

LOW NO_x TURBOPOWER® • PACKAGED WATER HEATER
AquaPLEX® STORAGE TANK (UNLINED DUPLEX ALLOY)

TANK SERIES 215 GALLONS VERTICAL

MODEL NUMBER	Recovery gph ①		INPUT Btu/h	Min. Inlet Flow Gas Pressure " W.C. ②	SCAQMD Energy Model No.		Dimensions (inches)		Blower Motor		Shipping Weight lbs
	40° - 120°F	40° - 140°F			A	B	HP	Amps			
1000 L 215A-TPL	1000	800	800,000	4.5	8TPL	800 MBtu/h	8	1	1/2	7	1430

- ① Recoveries based on 83% thermal efficiency. ASHRAE 90.1 compliant for efficiency and standby loss.
- ② With standard gas train
- * The information presented is for natural gas 0.6 S.G.
 Dimensions are in inches unless otherwise specified.
 For standard and optional equipment, see form #PV 8102.

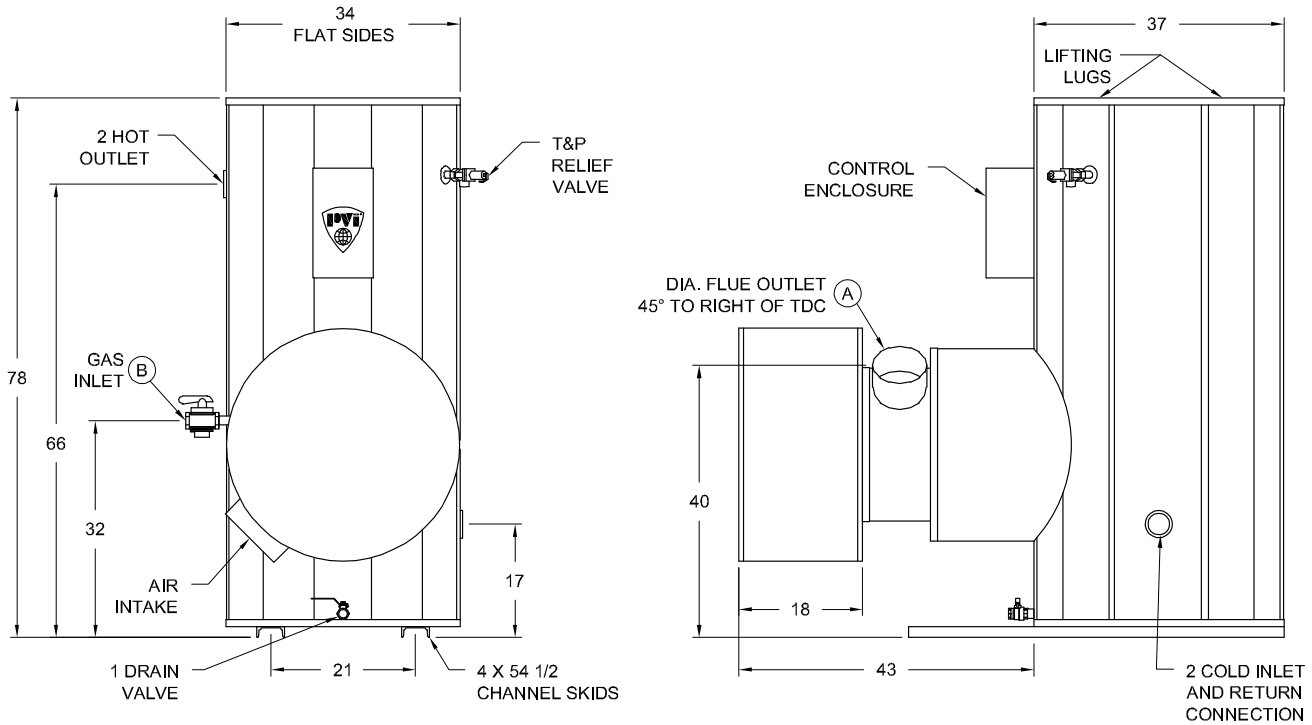

STANDARD GAS PRESSURE REQUIREMENTS:
 SEE TABLE FOR MINIMUM PRESSURE BY MODEL.
 MAXIMUM STATIC INLET GAS PRESSURE IS 10.5" W.C.
 FOR GAS PRESSURES OUTSIDE OF THIS RANGE,
 CONTACT YOUR PVI REPRESENTATIVE.

VENTING REQUIREMENTS:
 -.02" TO -.06" W.C. (NEGATIVE PRESSURE).
 TYPE B VENTING.
**ENTIRE VENT SYSTEM SHOULD NEVER BE SIZED BASED UPON
 THE VENT CONNECTION DIAMETER EXCLUSIVELY. CHECK
 NATIONAL FUEL GAS CODE UNDER "FAN ASSISTED."**

STANDARD ELECTRICAL REQUIREMENTS:
VOLTAGE: 120V, 1Ø, 60 HZ., 20 AMPS.
 OTHER VOLTAGES REQUIRE AN EXTERNAL
 STEPDOWN TRANSFORMER.

**PVI RESERVES THE RIGHT TO CHANGE THE DESIGN AND
 SPECIFICATION WITHOUT NOTICE.**



PVI INDUSTRIES, LLC
 FORT WORTH, TEXAS 76111
 (800) 784-8326 • www.pvi.com