

**AquaPLEX® Storage Tank (unlined duplex alloy)  
with COBREX® Steam Heat Exchanger - Double-wall  
DUAL EXCHANGER HIGH OUTPUT  
300 Gallon Tank Series - Dimensions**

Model No.	Amps @ 120V	Shipping Weight Lbs.
5400 L 300A-TCX	7	1780
7200 L 300A-TCX	8	1820

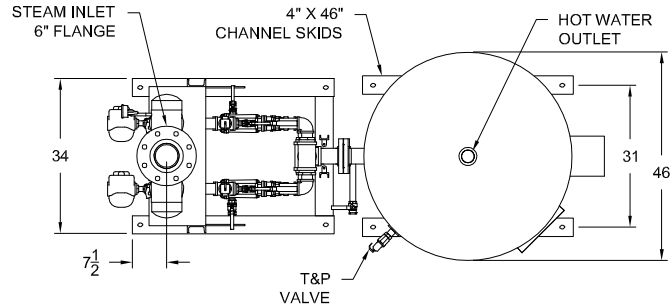

Refer to PV 8570 for standard and optional equipment.

Refer to PV 8587, PV 8588 and PV 8589 for detailed information on heat exchanger performance with different steam pressures and domestic water temperatures.

Steam pressures above 15 psi (125 psi max) require optional steam pressure reducing valve.

Recommended service clearance is 18 inches on all sides.

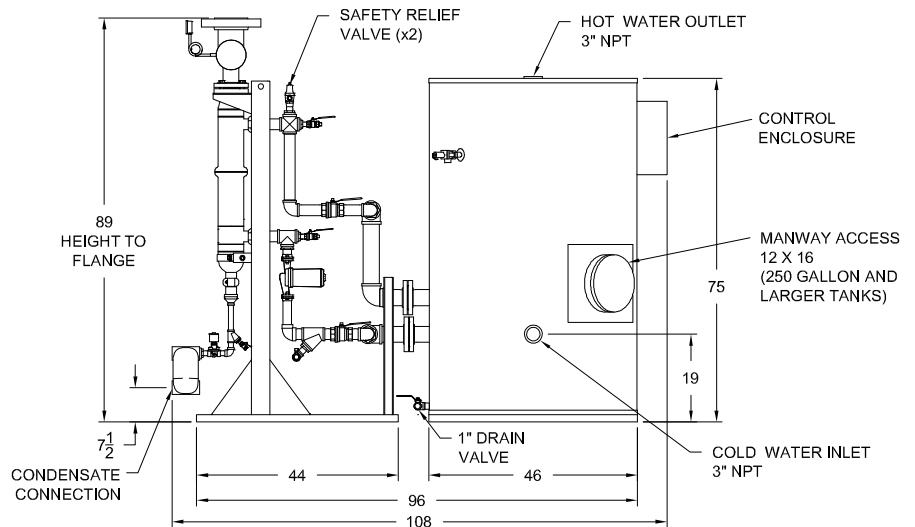

Completed piping assembly is factory fit between the exchanger and tank and is separated at unions for shipping.

Tank and heat exchanger ship separately for field connection to piping assembly.



**PVI INDUSTRIES, LLC**  
FORT WORTH, TX 76111  
(800) 784-8326 • www.pvi.com

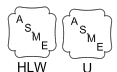

**PVI RESERVES THE RIGHT TO CHANGE THE DESIGN AND SPECIFICATION WITHOUT NOTICE.**