

**AquaPLEX® Storage Tank (unlined duplex alloy)  
with EZ PLATE® Boiler Water Heat Exchanger - Double-wall  
300 Gallon Tank Series - Dimensions**

Model No.	Amps @120V ①	A	B	Shipping Weight Lbs.
600 L 300A-TRBPDW	4	65	70	1255
900 L 300A-TRBPDW	4	65	70	1280
1200 L 300A-TRBPDW	4	65	70	1290
1800 L 300A-TRBPDW	5	65	70	1315
2400 L 300A-TRBPDW	5	65	70	1375
3000 L 300A-TRBPDW	5	65	70	1390
3600 L 300A-TRBPDW	5	72	70	1410
4500 L 300A-TRBPDW	8	72	70	1435
5400 L 300A-TRBPDW	8	72	70	1505
7200 L 300A-TRBPDW	14	77	81	1665

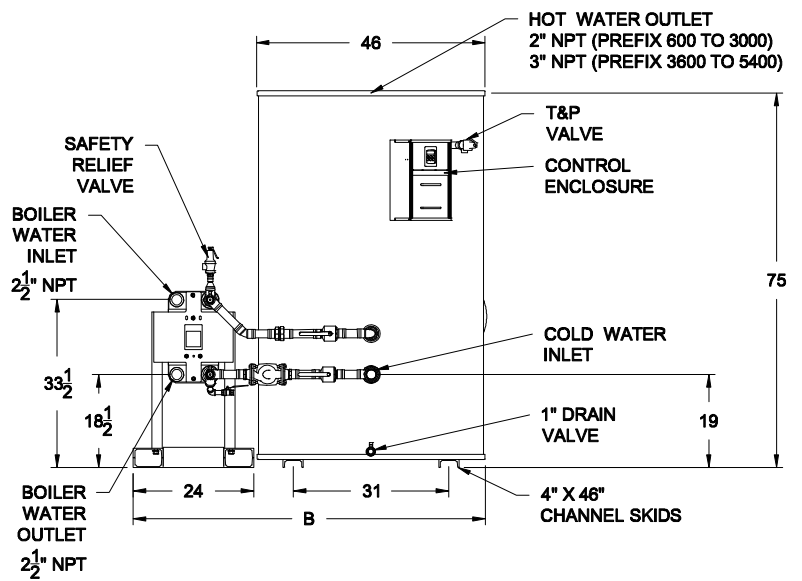
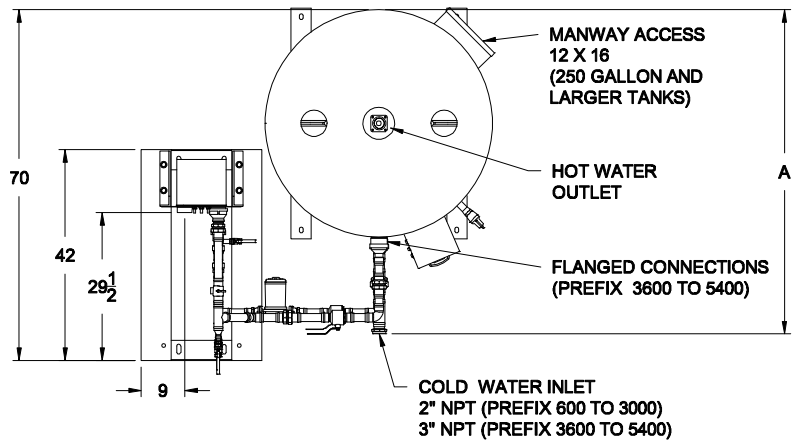

Refer to PV 8601, PV 8602 and PV 8603 for information on heat exchanger recoveries, pressure drop and boiler water flow requirements with various entering boiler water temperatures and domestic water temperatures.

Refer to PV 8600 for standard and optional equipment.

① Optional boiler water valve adds 2 amps

Recommended service clearance is 18 inches on all sides.

Completed piping assembly is factory fit between the exchanger and tank and separated at unions (or flanges) for shipping. Tank and heat exchanger ship separately for field assembly to piping assembly.

PVI reserves the right to change the design and specification without notice.

