

TURBOPOWER® 96 CONDENSING GAS WATER HEATERS

AquaPLEX® Storage Tank (duplex stainless steel)

Model No. 100 L 1000A-TPX	
Btu Input	1,000,000
Recovery GPH 70°F to 140°F ①	1652 (96% E _T)
Recovery GPH 40°F to 140°F	1175 (97.5% E _T)
Storage Capacity - gallons	1080
Gas Pressure Maximum Static	14" W.C.
Gas Pressure Minimum Flow	3.5" W.C.
Amperage (120VAC, 60Hz.)	11
Max. Inlet Air Duct Length @ 6" dia.	100 ft. with four 90° ells
Max. Vent Length @ 6" dia. ②	100 ft. with four 90° ells
Shipping Weight lbs.	3720

① Per DOE, 10 CFR 431 (ANSI Z21.10.3 @ 70°F to 140°F)

② Listed for category IV venting through PVC, CPVC, polypropylene, or single-wall stainless steel vent.

Refer to manual for design requirements.

Longer vents available with larger diameter.

Dimensions are in inches unless otherwise noted.

For standard and optional equipment, refer to form PV 8820.

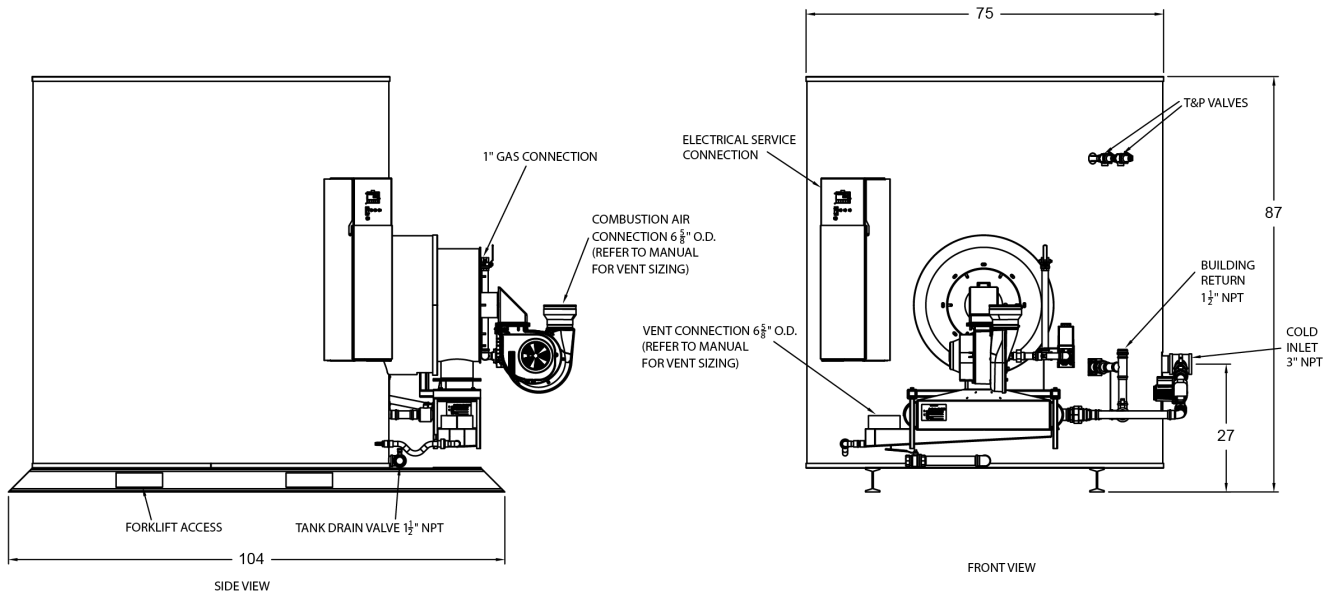
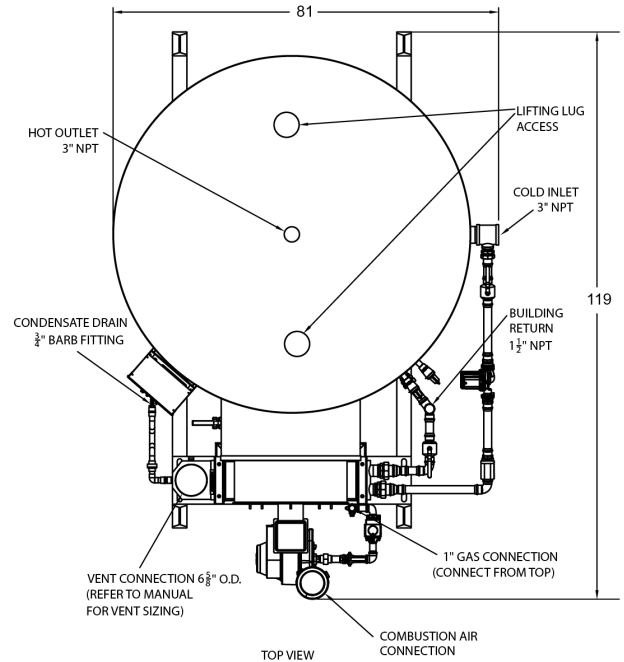

Recommended Service Clearance: 18" from all sides, 12" from the top. Consult factory for heat exchanger pull space requirements.
 Minimum Clearances: 6" from all sides and top, 24" from the front.

