

# TURBOPOWER® 96 CONDENSING GAS WATER HEATERS

## AquaPLEX® Storage Tank (duplex stainless steel)

<b>Model No. 130 L 1500A-TPX</b>	
Btu Input	1,300,000
Recovery GPH 70°F to 140°F ①	2148 (96% E <sub>T</sub> )
Recovery GPH 40°F to 140°F	1527 (97.5% E <sub>T</sub> )
Storage Capacity - gallons	1460
Gas Pressure Maximum Static	14" W.C.
Gas Pressure Minimum Flow	3.5" W.C.
Amperage (120VAC, 60Hz.)	15
Max. Inlet Air Duct Length @ 6" dia.	100 ft. with four 90° ells
Max. Vent Length @ 6" dia. ②	100 ft. with four 90° ells
Shipping Weight lbs.	4395

- ① Per DOE, 10 CFR 431 (ANSI Z21.10.3 @ 70°F to 140°F)
  - ② Listed for category IV venting through PVC, CPVC, polypropylene, or single-wall stainless steel vent. Refer to manual for design requirements. Longer vents available with larger diameter.
- Dimensions are in inches unless otherwise noted.  
For standard and optional equipment, refer to form PV 8820.

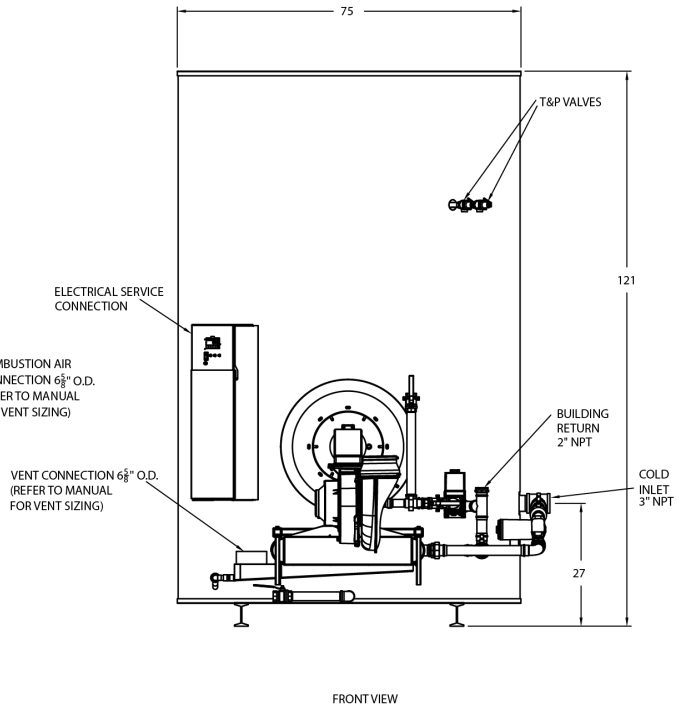
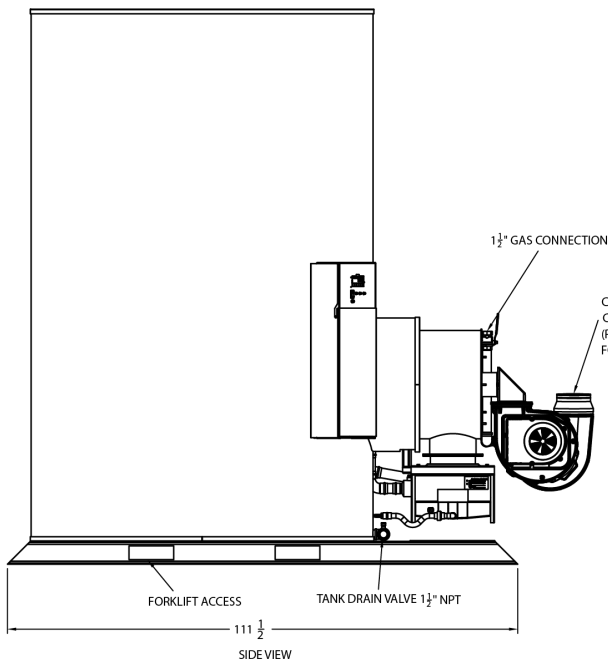
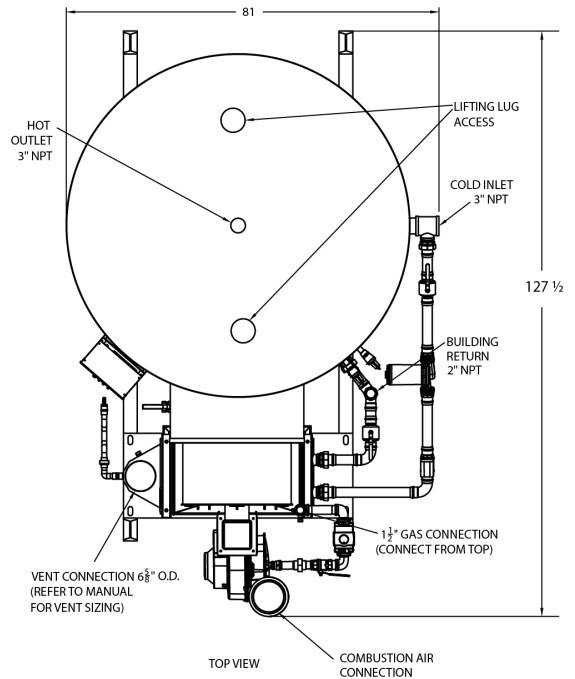

Recommended Service Clearance: 18" from all sides, 12" from the top. Consult factory for heat exchanger pull space requirements.

