

SERVICE & SETUP MANUAL



WATER HEATER ELECTRONIC CONTROLLER



PVI INDUSTRIES, LLC - Fort Worth, Texas 76111 - Web www.pvi.com - Phone 1-800-433-5654

INDEX

1. TECHNICAL DATA	3
2. WIRING DIAGRAMS	3
3. DISPLAY AND INTERFACE	4
3.1 KEYBOARD	4
3.2 LED ICON LEGEND	5
3.3 UPPER LED READOUT (RED)	6
3.4 LOWER LED READOUT (YELLOW)	6
3.5 TO SET THE CURRENT TIME AND DAY (24 HOUR CLOCK)	6
3.6 TO SET THE ENERGY SAVINGS TIME	7
3.7 TO SET THE MODULATION OUTPUT MANUALLY	7
3.8 HOW TO SEE THE WORKING HOURS OF RELAY OUTPUTS	7
3.9 HOW TO RESET THE WORKING HOURS OF RELAY OUTPUTS	7
4. PROGRAMMING	8
4.1 SET POINTS PROGRAMMING	8
4.2 HOW TO ENTER AND CHANGE PARAMETERS IN THE “pr1” LIST (NOT PASSWORD PROTECTED)	8
4.3 HOW TO ENTER PARAMETERS IN THE “Pr2” LIST (PASSWORD PROTECTED)	8
4.4 HOW TO CHANGE THE PARAMETER VALUES IN “Pr2”	9
4.5 HOW TO LOCK THE KEYBOARD	9
5. PARAMETERS	10
6. RELAY OUTPUTS	14
6.1 OUTPUT SETUP AND SPECS	14
6.2 OUTPUT 1 CALL FOR HEAT (1on=rEG)	14
6.3 OUTPUT 2 2ND STAGE (oS2=Std 2on=rEG)	15
6.4 OUTPUT 2 AS ALARM RELAY (oS2=AL, 2ON=REG)	15
6.5 OUTPUT 3 TEMPERATURE PROTECTION (3on=rEG)	16
6.6 OUTPUT 3 ALTERNATE SET POINT	17
7. MODULATION OUTPUT	18
8. MODULATION BUFFER	19
9. DYNAMIC RESET OF St1	19
10. WARM WEATHER SHUT DOWN	19
11. HOT KEY PROGRAMMING	20
12. ASSIGNING TEMPTRAC® ADDRESS FOR MODBUS RTU	21
13. ALARMS	22
13.1 DIGITAL INPUT ALARMS	23
13.2 AUDIBLE ALARM	23
13.3 ALARM RECOVERY	24

1. TECHNICAL DATA

Housing: Self-extinguishing ABS.

Case: Facia 100x64 mm; depth 76mm

Mounting: Panel mounting in a 56x72 mm panel cut-out with two screws. \varnothing 3x2mm. Distance between the holes 40mm

Protection: IP20.

Frontal protection: IP65 with optional frontal gasket mod. RGW-V

Connections: Spade on connectors 6.3 mm for supply and relays and 4÷20mA-

Screw terminals block for probes, digital input

Power supply: 24Vac Class 2

Power absorption: 7VA max.

Display: Dual display

Relay outputs: 3 SPST relay contacts, 3A, 8A resistive load.

Other output: Audible alarm

4÷20mA modulation output

Inputs: 3 NTC probes

Digital inputs: 3 Dry Contact

Hot key facility for fast programming

Serial output: TTL standard

Communication protocol: Modbus - RTU

Data storing: On non-volatile memory (EEPROM).

Internal clock back-up: 24 hours

Kind of action: 1B.

Pollution grade: Normal

Software class: A.

Operating temperature: 32÷140°F (0÷60 °C)

Storage temperature: -13÷140°F (-25÷60 °C)

Relative humidity: 20÷85% (no condensing)

Measuring and regulation range: NTC probe: -58÷230°F (-40÷110°C)

Resolution: 1°F or 1 °C (selectable).

Accuracy (ambient temp. 77°F): ± 1 °F ± 1 digit



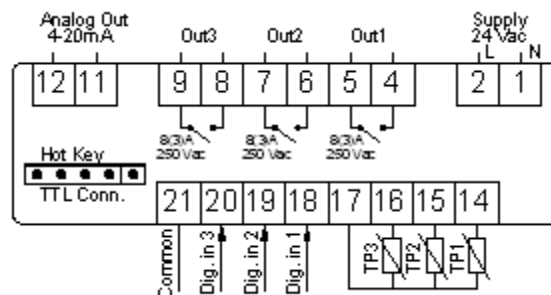

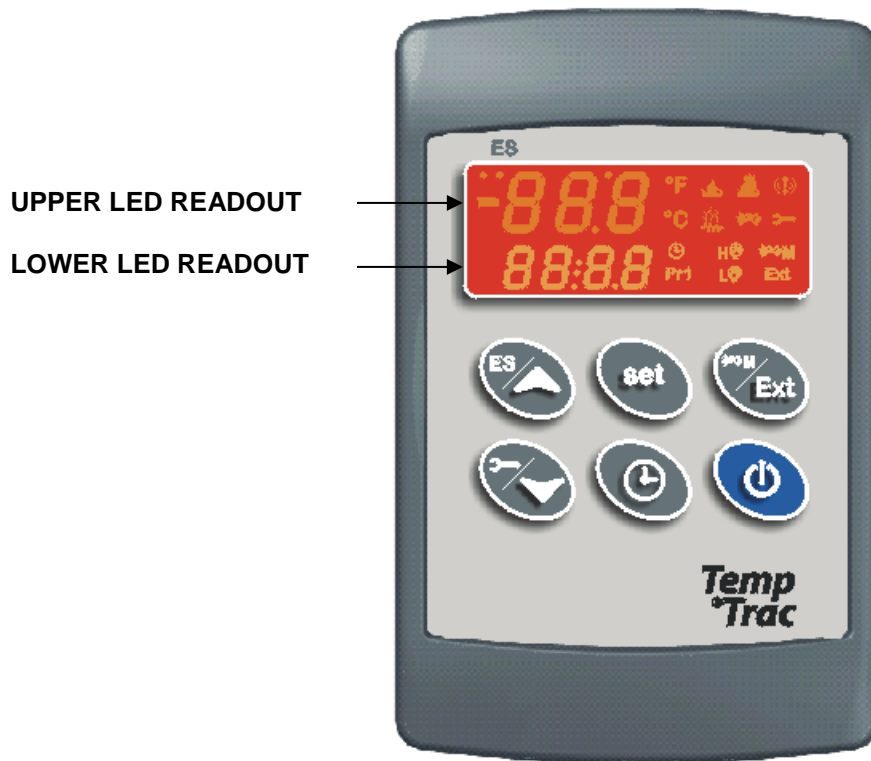

2. WIRING DIAGRAMS



3. DISPLAY AND INTERFACE



3.1 KEYBOARD

-  - Displays and modifies the temperature set points.
SET - In programming mode it selects a parameter or confirms an operation.
-  - Displays and modifies the energy saving (Night Time Setback) settings.
UP - In programming mode it browses the parameter codes or increases the displayed value.
-  - Displays the working hours of the load relays.
DOWN - In programming mode it browses the parameter codes or decreases the displayed value.
-  - Changes lower display from inlet temperature to current time and day.
CLOCK - To set the current time and day.
-  - Changes upper display between outlet temperature, inlet temperature, outdoor reset temperature, modulation % or the temperature difference between the inlet and outlet temperatures.
EXT - In programming mode it sets the modulation output (4-20mA). (Password is required (321).
-  - Switches the control ON or OFF.
ON/OFF

KEY COMBINATIONS



To lock and unlock the keyboard.



To enter the programming mode.



To exit the programming mode.

3.2 LED ICON LEGEND

LED	MODE	Function
°F	ON	Temperatures are displayed in degrees Fahrenheit.
°C	ON	Temperatures are displayed in degrees Celsius.
	Flashing	Output 1 time delay. Output 1 will not energize until AC1 time delay expires OR i3F=Edi and the remote enable/disable is in standby (disabled).
	ON	Output 1 relay is on. Spade contacts 4 & 5 are closed. Usually this is the primary CALL FOR HEAT.
	Flashing	Output 2 time delay. Output 2 will not energize until AC2 time delay expires. (On 2-stage units only.) Or oS2 is set to AL . (Output 2 is an alarm indicator and it is off.)
	ON	Output 2 relay is on or the AL2 alarm output is enabled. Spade contacts 6 & 7 are closed.
	Flashing	Output 3 time delay. Output 3 will not energize until AC3 time delay expires.
	ON	Output 3 relay is on. Spade contacts 8 & 9 are closed.
	ON	Modulation output signal is in manual control mode. Parameter PS4 should be set to nu for automatic operation. Or If dS1 or dS2 is set to display the modulation output value ANI .
	Flashing	Modulation is forced to value in i1S by digital input 1.
	ON	Modulation output signal is automatically controlled by temperature probe 1.
	Flashing	Modulation output time delay is activated. Modulation output will remain at 4mA until the AC4 time delay expires. Or Modulation will remain in low fire until probe 2 is below TH4 by the amount of HY4 .
Ext	ON	The outside temperature is displayed (top or bottom display). See dS1 & dS2 .
	FLASHING	Digital input 2 (alarm) is activated.
	FLASHING	Digital input 3 (alarm) is activated.
 	FLASHING	When both and are flashing other safety interlocks such as low water cut-off or high temperature limit may be in failure.
	ON	Lower LED display is displaying time clock.
Pr1	ON	While in the Pr2 menu, signals that current the parameter is accessible in the Pr1 menu.
	FLASHING	ALARM signal (any alarm condition LA, HA, P1, P2, P3, AL2, AL3, Nn1, Nn2, Nn3).
	FLASHING	Programmed working hours limit is exceeded. See oP1 , oP2 , oP3 & ou1 , ou2 , ou3 .
	ON	Working hours are displayed in the lower LED display.
ES	ON	The Energy saving function is running. This is a LED dot under the ES label top left.
PoF	Pops Up	Displayed when trying to make a change, the Keypad is locked. See section 4.5 .

3.3 UPPER LED READOUT (RED)

The default display of this readout is the temperature sensed at Probe 2. Probe 2 may display the tank stored water temperature, outlet water temperature, flue gas temperature, ambient temperature, remote tank or blended water temperature, etc., depending on the product and application. Refer to your specific water heaters Installation and Maintenance Manual and the supplied wiring drawing. The upper LED readout can also be switched to display Probe 1 or 3 (if used) or the modulation % or the temperature difference between Probe 1 and 2. If Probe 2 is not utilized, the display will show “nu”.

By pressing and releasing the  button once, the Upper LED will display the actual temperature sensed at Probe 3. Probe 3 (if used) may display the flue gas temperature or outside ambient temperature, etc., depending on the product and application.

By pressing and releasing the  button again, the Upper LED will display the modulation %. If the product is a non-modulating product, the displayed valve should not be considered.

By pressing and releasing the  button a third time, the Upper LED will display the difference between the temperature sensed at Probe 2 (if used) and the temperature sensed at Probe 1.

To return to the default in the Upper LED readout, press the  button to cycle back to the Probe 2 temperature.



All of the display information described above is available for monitoring through the optional MODBUS RTU interface.



3.4 LOWER LED READOUT (YELLOW)

The default display of this readout is the temperature sensed at Probe 1. Probe 1 will be inserted into the appropriate area of the storage tank to provide effective temperature response for the heat source (this may not be at the top of the tank). The lower LED readout can also be switched to display Probe 2 or 3 (if used) or the modulation % or the Time of Day.





By pressing and releasing the  button once, the Lower LED display will show the Time of Day. Press again to return to default display.



3.5 TO SET THE CURRENT TIME AND DAY (24 HOUR CLOCK)

1. Push and hold the  button for more than 3 seconds. The  LED ICON starts flashing and the “Hur” (hour) parameter name is displayed in the Upper LED readout, its value is displayed in the Lower LED readout.

2. Pushing the  or  button alternates the LED readouts between the following:









- “Hur” (hour) in the Upper readout and its value in the lower readout.
- “Min” (minute) in the Upper readout, its value in the Lower readout.
- “dAY” (day) in the Upper readout, its value in the Lower readout.

3. To adjust a value, press the  button and the value in the Lower LED will start flashing. Change the value by pressing the  or  buttons. When correct, press .







4. To exit push  +  or wait 15 seconds without pressing any buttons.

NOTE: This device recognizes Sunday as the first day of the week and Saturday as the last.

3.6 TO SET THE ENERGY SAVINGS TIME







1. Push the  button for more than 3 seconds and the first parameter of the energy saving will be displayed.
2. Use  and  keys to browse them.
3. To change a value push  key followed by  or .
4. To exit, press  and  or wait 30s without pressing any key.

3.7 TO SET THE MODULATION OUTPUT MANUALLY



1. Push and hold the  key for more than 3 seconds  LED switches ON and the **PS4** parameter is displayed in the upper display, while the **PAS** label is shown in the lower display. The passkey will be required to view and manually change the modulation % value. Passkey is "321".
2. Release the key, and insert the password as described in the par. 4.3. The value of **PS4** will be displayed in the lower display. **(nu)** stands for not used. Return to this condition for automatic operation.
3. To adjust modulation manually, push the  key, the value starts flashing. Then use  or  keys to modified it.
4. To exit, press  and  or wait 30s without pressing any key.

NOTE: After a modification, it will be possible to enter the Modulation output setting without entering the password for 10min. After this time you will be asked for the password again.

3.8 HOW TO SEE THE WORKING HOURS OF RELAY OUTPUTS







1. Push the  key for more than 3 seconds,  LED switches ON, the display 2 will show **ou1** and the display 1 will show the working hours of the relay 1.
2. By pushing  or  keys, the working hours of other outputs are displayed.
3. To exit, press  and  or wait 30s without pressing any key.

3.9 HOW TO RESET THE WORKING HOURS OF RELAY OUTPUTS

1. To reset the working hours of a load enter Pr2 menu. See [section 4.3](#).
2. Select the parameter: **ou1** for the output 1 or **ou2** for output 2 or **ou3** for output 3.
3. Push the  key, and the value will start flashing, use the  key to decrease the value.

4. PROGRAMMING

4.1 SET POINTS PROGRAMMING







1. Push the  key, the upper display will show the “St1”, while the lower display will show its value.
2. Use the  and  key to see the set point to be modified.
3. Push the  key to modify the displayed value. It starts flashing.
4. To change it push the  or  keys.
5. Push the  key to confirm the value and pass to the setting of next set point.
6. Repeat the operations for additional set points.



To exit: press  and  or wait 30s without pressing any key.

NOTE: Each point has a time out of 30 seconds. If no key is pressed within 30s the controller exits the set points programming procedure.

NOTE: The set value is stored even when the procedure exits due to the 15 second expiration.

4.2 HOW TO CHANGE PARAMETERS IN THE “Pr1” LIST (NOT PASSWORD PROTECTED)



1. Enter the Programming mode by pressing the  and  key for 3s.
2. Select the required parameter. The name of the parameter is on the upper display and its value is on the lower display.
3. Press the  key: the value of the parameter will start blinking.
4. Use  or  to change the value.
5. Press  to store the new value and move to the following parameter.

To exit: Press  and  and or wait 30s without pressing a key.

NOTE: The set value is stored even when the procedure exits due to the 15 second expiration.

4.3 HOW TO ENTER PARAMETERS IN THE “Pr2” LIST (PASSWORD PROTECTED)

1. Enter the “Pr1” level.
2. Press the DOWN key.
3. Select “Pr2” – “PAS” parameter and press the  key.
4. The value “0 - -” with a flashing zero is displayed.

Use  or  keys to input the security code in the flashing digit; confirm the figure by pressing .



5. The security code is “321”.

NOTE: each parameter in “Pr2” can be removed or put into “Pr1” (user level) by pressing  + .

When a parameter is present also in “Pr1” the “Pr1” icon is on.

4.4 HOW TO CHANGE THE PARAMETER VALUES IN “Pr2”

1. Enter the Programming mode.

2. Select the required parameter with  or  keys.

3. Press the  key and the value will start blinking.

4. Use  or  keys to change its value.



5. Press  to store the new value and move to the next parameter.

To exit: Press  and  or wait 30s without pressing a key.

NOTE: the new programming is stored even if the procedure exits by time-out.

4.5 HOW TO LOCK THE KEYBOARD



1. Keep the  and  keys pressed together for more than 3 s.

2. The “PoF” message will be displayed and the keyboard is locked. At this point it is only possible to view the set point. Any attempt to change a set point will display the “PoF” message.

3. Repeat step 1 to unlock the keyboard.

4. The “Pon” message will be displayed and the keyboard will be unlocked.

5. PARAMETERS

All the parameters can be set in:

- Pr1: immediately accessible menu.
- Pr2: password protected menu.

Label: The displayed label when using the Keypad.

Range: Indicates the possible values and units that can be set.

Firm Version: Firmware of the TempTrac control can be viewed in the rEL parameter.

Label	Firm Version	Description	Range X÷Y From X to Y	Rev 0.3 Level	Rev 0.5 Level	Hex Modbus Address Base 0	Modbus Command Address 40000+
St1	0.3 & 0.5	Set point1	LS1÷US1	Pr1	Pr1	0x300	769
St2	0.3 & 0.5	Set point2	LS2÷US2	Pr1	Pr1	0x301	770
St3	0.3 & 0.5	Set point3	LS3÷US3	Pr1	Pr1	0x302	771
St5	0.3 & 0.5	Set point5 Set point 3 alternate	-20÷70°F	Pr1	Pr1	0x303	772
HY1	0.3 & 0.5	Differential for St1	-22÷22°F	Pr2	Pr2	0x304	773
LS1	0.3 & 0.5	Minimum set point1	-40°F÷SET	Pr2	Pr2	0x305	774
US1	0.3 & 0.5	Maximum set point1	SET ÷ 230°F	Pr2	Pr2	0x306	775
AC1	0.3 & 0.5	Anti-short cycle delay for output 1	0÷30 min.	Pr2	Pr2	0x307	776
S2c	0.3 & 0.5	Configuration of St2: dependent on St1 or independent	diP; ind	Pr3	Pr2	0x308	777
HY2	0.3 & 0.5	Differential for St2	-22÷22°F	Pr2	Pr2	0x309	778
LS2	0.3 & 0.5	Minimum set point2	-40°F÷St2	Pr2	Pr2	0x30A	779
uS2	0.3 & 0.5	Maximum set point2	St2 ÷ 230°F	Pr2	Pr2	0x30B	780
AC2	0.3 & 0.5	Anti-short cycle delay for output 2	0÷30 min.	Pr2	Pr2	0x30C	781
S3c	0.3 & 0.5	Configuration of St3: dependent on St1 or independent	diP; ind	Pr2	Pr2	0x30D	782
HY3	0.3 & 0.5	Differential for set point 3 St3	-22÷22°F	Pr2	Pr2	0x30E	783
LS3	0.3 & 0.5	Minimum set point 3 St3	-40°F÷St3	Pr2	Pr2	0x30F	784
uS3	0.3 & 0.5	Maximum set point 3 St3	St3 ÷ 230°F	Pr2	Pr2	0x310	785
AC3	0.3 & 0.5	Anti-short cycle delay for output 3	0÷30 min.	Pr2	Pr2	0x311	786
o3P	0.3 & 0.5	Probe selection for output 3	Pb1 / Pb2	Pr2	Pr2	0x312	787
SSE	0.3 & 0.5	Set point shift for output 3 enable disable	No; Yes	Pr2	Pr2	0x313	788
HY5	0.3 & 0.5	Differential for set point 5	-22÷22°F	Pr2	Pr2	0x314	789
Ac5	0.3 & 0.5	Anti-short cycle delay for output 3 alternate set point	0÷30 min.	Pr2	Pr2	0x315	790
AcA	0.3 & 0.5	Time delay between the St3 to St5 set point shift	0÷15 min.	Pr2	Pr2	0x316	791
		ANALOGUE OUTPUT 4÷20mA (output 4)					
S4c	0.3 & 0.5	Configuration of St4: dependent on St1 or independent	diP; ind	Pr3	Pr2	0x317	792
St4	0.3 & 0.5	Analogue output set point	-100÷100°F	Pr2	Pr2	0x318	793
SR	0.3 & 0.5	Analogue output band width	-100÷100°F	Pr2	Pr2	0x319	794
Th4	0.3 & 0.5	Outlet temperature threshold for forcing to 4ma the analog output	-40°F ÷ 230°F	Pr2	Pr2	0x31A	795
HY4	0.3 & 0.5	Differential for restart working of analog output	-45 ÷ -1 °F	Pr2	Pr2	0x31B	796
Ac4	0.3 & 0.5	Anti-short cycle delay for output 4	0÷30 min.	Pr2	Pr2	0x31C	797
PS4	0.3 & 0.5	Analog output percentage (nu=101)	0÷100, nu	Pr2	Pr2	0x31D	798
PP4	0.3 & 0.5	Analog output percentage with fault probe 1 (nu=101)	0÷100, nu	Pr3	Pr2	0x31E	799
		DYNAMIC RESET					
tt	0.3 & 0.5	Outdoor temperature threshold for dynamic reset of St1	-40÷230°F	Pr2	Pr2	0x31F	800
rr2	0.3 & 0.5	Outdoor temperature band width	-100÷100°F	Pr2	Pr2	0x320	801
rr1	0.3 & 0.5	Maximum shift of St1	-100÷100°F	Pr2	Pr2	0x321	802
tt2	0.3 & 0.5	Outdoor temperature threshold to open all the loads	-40÷230°F	Pr2	Pr2	0x322	803
Ht2	0.3 & 0.5	Differential for restart working of controller	-45 ÷ -1 °F	Pr2	Pr2	0x323	804

Label	Firm Version 0.3 & 0.5	Description	Range X÷Y From X to Y	Rev 0.3 Level	Rev 0.5 Level	Hex Modbus Address Base 0	Modbus Command Address 40000+
DIGITAL INPUTS							
i1P	0.3 & 0.5	Digital input 1 polarity	CL÷OP	Pr3	Pr2	0x324	805
i2P	0.3 & 0.5	Digital input 2 polarity	CL÷OP	Pr2	Pr2	0x325	806
i2d	0.3 & 0.5	Digital input 2 alarm delay	0÷255 min.	Pr3	Pr2	0x326	807
i3P	0.3 & 0.5	Digital input 3 polarity	CL÷OP	Pr2	Pr2	0x327	808
i3d	0.3 & 0.5	Digital input 3 alarm delay	0÷255 min.	Pr3	Pr2	0x328	809
DISPLAY							
cF	0.3 & 0.5	Temperature measurement unit	°C ÷ °F	Pr3	Pr2	0x329	810
rES	0.3 & 0.5	Resolution (integer/decimal point) only for °C	in ÷ de	Pr3	Pr2	0x32A	811
dS2	0.3	Default showing for display #2 Top (red)	Pb2, Pb3	Pr2		0x32B	812
dS2	0.5	Default showing for display #2 Top (red) Pb3 will display yellow EXT, Ani will display yellow Valve/M	Pb1,Pb2,Pb3,AnI		Pr2	0x32B	812
dS1	0.3	Default showing for display #1 Bottom (Yellow)	Pb1; tiM	Pr2		0x32C	813
dS1	0.5	Default showing for display #1 Bottom (Yellow) Pb3 will display yellow EXT, Ani will display yellow Valve/M	Pb1,Pb2,Pb3,AnI, TiM		Pr2	0x32C	813
ALARMS							
Alc	0.3 & 0.5	Temperature alarms configuration: dependent on St1 or independent	rE÷Ab	Pr3	Pr2	0x32D	814
ALL	0.3 & 0.5	minimum temperature alarm, referred to TP1	-40÷230°F	Pr2	Pr2	0x32E	815
Alu	0.3 & 0.5	MAXIMUM temperature alarm, referred to TP1	-40÷230°F	Pr3	Pr2	0x32F	816
AFH	0.3 & 0.5	Differential for temperature alarm recovery	1÷45°F	Pr2	Pr2	0x330	817
ALd	0.3 & 0.5	Temperature alarm delay	0÷255 min.	Pr2	Pr2	0x331	818
dAo	0.3 & 0.5	Delay of temperature alarm at start up 1 = 10 min disp 0.1	0 ÷ 23h 50 min.	Pr2	Pr2	0x332	819
ANALOGUE INPUTS							
oF1	0.3 & 0.5	First probe calibration	-21÷21°F	Pr3	Pr2	0x333	820
P2P	0.3 & 0.5	Second probe presence	No; Yes	Pr2	Pr2	0x334	821
oF2	0.3 & 0.5	Second probe calibration	-21÷21°F	Pr3	Pr2	0x335	822
P3P	0.3 & 0.5	Third probe presence	No; Yes	Pr2	Pr2	0x336	823
oF3	0.3 & 0.5	Third probe calibration	-21÷21°F	Pr3	Pr2	0x337	824
TIME AND DATE							
Hur	0.3 & 0.5	Current hour	0 ÷ 23	Pr2	Pr2	0x338	825
Min	0.3 & 0.5	Current minute	0 ÷ 59	Pr2	Pr2	0x339	826
dAY	0.3 & 0.5	Current day	Sun ÷ SAT	Pr2	Pr2	0x33A	827
ENERGY SAVING TIMES							
E1	0.3 & 0.5	Energy saving start on Sunday	0 ÷ 23h 50 min. - nu	Pr2	Pr2	0x33B	828
S1	0.3 & 0.5	Energy saving stop on Sunday	0 ÷ 23h 50 min. - nu	Pr2	Pr2	0x33C	829
Sb1	0.3 & 0.5	Set back temperature on Sunday	-40÷40°F	Pr2	Pr2	0x33D	830
E2	0.3 & 0.5	Energy saving start on Monday	0 ÷ 23h 50 min. - nu	Pr2	Pr2	0x33E	831
S2	0.3 & 0.5	Energy saving stop on Monday	0 ÷ 23h 50 min. - nu	Pr2	Pr2	0x33F	832
Sb2	0.3 & 0.5	Set back temperature on Monday	-40÷40°F	Pr2	Pr2	0x340	833
E3	0.3 & 0.5	Energy saving start on Tuesday	0 ÷ 23h 50 min. - nu	Pr2	Pr2	0x341	834
S3	0.3 & 0.5	Energy saving stop on Tuesday	0 ÷ 23h 50 min. - nu	Pr2	Pr2	0x342	835
Sb3	0.3 & 0.5	Set back temperature on Tuesday	-40÷40°F	Pr2	Pr2	0x343	836
E4	0.3 & 0.5	Energy saving start on Wednesday	0 ÷ 23h 50 min. - nu	Pr2	Pr2	0x344	837
S4	0.3 & 0.5	Energy saving stop on Wednesday	0 ÷ 23h 50 min. - nu	Pr2	Pr2	0x345	838
Sb4	0.3 & 0.5	Set back temperature on Wednesday	-40÷40°F	Pr2	Pr2	0x346	839
E5	0.3 & 0.5	Energy saving start on Thursday	0 ÷ 23h 50 min. - nu	Pr2	Pr2	0x347	840
S5	0.3 & 0.5	Energy saving stop on Thursday	0 ÷ 23h 50 min. - nu	Pr2	Pr2	0x348	841

Label	Firm Version	Description	Range X÷Y From X to Y	Rev 0.3 Level	Rev 0.5 Level	Hex Modbus Address Base 0	Modbus Command Address 40000+
Sb5	0.3 & 0.5	Set back temperature on Thursday	-40÷40°F	Pr2	Pr2	0x349	842
E6	0.3 & 0.5	Energy saving start on Friday	0 ÷ 23h 50 min. - nu	Pr2	Pr2	0x34A	843
S6	0.3 & 0.5	Energy saving stop on Friday	0 ÷ 23h 50 min. - nu	Pr2	Pr2	0x34B	844
Sb6	0.3 & 0.5	Set back temperature on Friday	-40÷40°F	Pr2	Pr2	0x34C	845
E7	0.3 & 0.5	Energy saving start on Saturday	0 ÷ 23h 50 min. - nu	Pr2	Pr2	0x34D	846
S7	0.3 & 0.5	Energy saving stop on Saturday	0 ÷ 23h 50 min. - nu	Pr2	Pr2	0x34E	847
Sb7	0.3 & 0.5	Set back temperature on Saturday	-40÷40°F	Pr2	Pr2	0x34F	848
		WORKING HOURS					
ou1	0.3 & 0.5	working hours actual of relay 1	0÷9999h	Pr1	Pr2	0x350	849
ou2	0.3 & 0.5	working hours actual of relay 2	0÷9999h	Pr1	Pr2	0x351	850
ou3	0.3 & 0.5	working hours actual of relay 3	0÷9999h	Pr2	Pr2	0x352	851
oP1	0.3 & 0.5	working hours limit of relay 1	0÷9999h; with 0 the function is disabled	Pr2	Pr2	0x353	852
oP2	0.3 & 0.5	working hours limit of relay 2	0÷9999h; with 0 the function is disabled	Pr2	Pr2	0x354	853
oP3	0.3 & 0.5	working hours limit of relay 3	0÷9999h; with 0 the function is disabled	Pr2	Pr2	0x355	854
		OUTPUTS SETTING					
1on	0.3 & 0.5	The output 1 is always on or depending on temperature	rEG=1,1;YES=0,1; no=0,0	Pr2	Pr2	0x356	855
2on	0.3 & 0.5	The output 2 is always on or depending on temperature	rEG=1,1;YES=0,1; no=0,0	Pr2	Pr2	0x357	856
3on	0.3 & 0.5	The output 3 is always on or depending on temperature	rEG=1,1;YES=0,1; no=0,0	Pr2	Pr2	0x358	857
		OTHER					
Adr	0.3 & 0.5	Serial address	0÷247	Pr2	Pr2	0x359	858
Ptb	0.3 & 0.5	Parameter map code always = 1	readable only	Pr2	Pr2	0x35A	859
rEL	0.3 & 0.5	Software release 5 = 0.5, 3 = 0.3	readable only	Pr2	Pr2	0x35B	860
i1S	0.5	Analog output when Digital Input 1 is activated	4-20mA		Pr2	0x35C	861
i1t	0.5	Analog output at i1S extra time if Digital Input 1 is not activated	0÷30 sec.		Pr2	0x35D	862
i1d	0.5	Digital Input 1 Alarm Delay	0÷255 min.		Pr2	0x35E	863
i1F	0.5	If Yes, Digital Input 1 will function as Alarm. Operating only when trying to call for output 1 and Input 1 is active, subject to i1d timer	No; Yes		Pr2	0x35F	864
i2F	0.5	Digital Input 2 will function only when Output 1 is energized	No; Yes		Pr2	0x360	865
i3F	0.5	Digital Input 3 will function only when Output 1 is energized, When Edi is selected, Output 1 will open when digital input 3 is activated	No; Yes; Edi		Pr2	0x361	866
oS2	0.5	Output 2 function: either temp relay or alarm relay	Std; AL		Pr2	0x362	867
	0.3 & 0.5	Probe 1 temperature	Degrees F/C		Pr2	0x100	257
	0.3	Probe 1 Information/Status Normal=512 or 0x0200, Fault=515 or 0x0203. Fault will, drop call for heat, buz, Flash Yellow P1, light yellow valve/M	bit (0,1 on) probe failure		Pr2	0x101	258
	0.3 & 0.5	Probe 2 temperature	Degrees F/C		Pr2	0x102	259
	0.3	Probe 2 Information/Status Normal=512 or 0x0200, Fault=515 or 0x0203. Fault will buz, Flash Red P2	bit (0,1 on) probe failure		Pr2	0x103	260
	0.3 & 0.5	Probe 3 temperature	Degrees F/C		Pr2	0x104	261

	0.3	Probe 3 Information/Status Normal=512 or 0x0200, Fault=515 or 0x0203. Fault will buz, Flash Red P3	bit (0,1 on) probe failure		Pr2	0x105	262
	0.5	Modulation rate output (4 to 20mA)	0÷100%		Pr2	0x106	263
	0.3 & 0.5	Status of Relay 1,2&3	bit 0,1,2		Pr2	0x801	2050
	0.3	Input 3 Alarm, buz, ALMMB, Flashes HP= 4096 or 0x0800	bit # 12 or 13th bit		Pr2	0xD00	3329
	0.3	Input 2 Alarm, buz, Flashes LP= 4096 or 0x0800	bit # 12 or 13th bit		Pr2	0xD00	3329
	0.3	Input 2 & 3, buz, Flashed HP & LP= 4096 or 0x0800	bit # 12 or 13th bit		Pr2	0xD00	3329
	0.5	Low Temperature Alarm, beep, Flash Yellow LA= 1 or 0x0001	bit # 0 or 1st bit		Pr2	0xD00	3329
	0.5	High Temperature Alarm, beep, Flash yellow HA= 2 or 0x0002	bit # 1 or 2nd bit		Pr2	0xD00	3329
	0.5	Probe 1 error, open or shorted, Drops call for heat, yel valve/M on, Flash Yellow P1=4 or 0x0004	bit # 2 or 3rd bit		Pr2	0xD00	3329
	0.5	Probe 2 error, open or shorted, Flashing red P2=256 or 0x0100	bit # 8 or 9th bit		Pr2	0xD00	3329
	0.5	Probe 3 error, open or shorted, Flashing red P3=512 or 0x0200	bit # 9 or 10th bit		Pr2	0xD00	3329
	0.5	ALARM 1 (stops heating) Input 1, beep, Flash AL1 = 1024 or 0x0400. Will recover is Input 1 goes away, or need for call for heat goes away.	bit # 10 or 11th bit		Pr2	0xD00	3329
	0.5	ALARM 2 (Lockout, stops heating) Input 2, Flash AL2 & Lguage & valve= 2048 or 0x1000	bit # 11 or 12th bit		Pr2	0xD00	3329
	0.5	ALARM 3 (Lockout, stops heating) Input 3/ALMMB/ALOAF, beep, Flash AL3 & Hguage & valve (This is ALARM ON ANY FAILURE)= 4096 or 0x0800	bit # 12 or 13th bit		Pr2	0xD00	3329
	0.5	Maintenance Relay1, beep, Flash Nn1 & wrench=8192 or 0x2000 You must reset hours ou1 or set oP1=0	bit # 13 or 14th bit		Pr2	0xD00	3329
	0.5	Maintenance Relay2, beep, Flash Nn2 & wrench=16384 or 0x4000 You must reset hours ou2 or set oP2=0	bit # 14 or 15th bit		Pr2	0xD00	3329
	0.5	Maintenance Relay3, beep, Flash Nn3 & wrench=32768 or 0x8000 You must reset hours ou3 or set oP3=0	bit # 15 or 16th bit		Pr2	0xD00	3329
	0.3	On/Off On=257 or 0x0101, Off=1 or 0x0001 Can be used to reset ALMMB alarm by cycling OFF, wait 30 sec , ON	Low byte is mask, Hi byte is command. Bit # 0 & #8		Pr2	0x500	1281
	0.3	Keyboard Lock Lock=2056 or 0x0808, Unlock=8 or 0x0008. If locked PoF is displayed when keypad edit is attempted	Low byte is mask, Hi byte is command. Bit # 3 & #11		Pr2	0x500	1281
	0.3	Reset audible alarm when condition is corrected, 4112 or 0x1010 does not reset alarm, just stops the beeping	Low byte is mask, Hi byte is command. Bit # 3 & #12		Pr2	0x500	1281
		Energy Savings Registers are enumerated 0 to 145 w/145=n/u					

6. RELAY OUTPUTS

6.1 OUTPUT SETUP AND SPECS

- 3 relay outputs. SPST relay contacts going to spade terminals #4-9.
- The outputs are rated at 3A, or 8A resistive load.
- Each output (1-3) can be controlled via Modbus RTU Communication by setting **on** or **oFF** to the **1on**, **2on**, **3on** parameters.
- Each output can be configured to operate as a control output, typically for temperature control. This is done when **1on**, **2on**, **3on** respectively are set to **rEG**. This is the default setting.
 - 1on=rEG** Output 1 is configured for Temperature Control (Same for **2on**, **3on**).
 - 1on=oFF** Output 1 is off.
 - 1on=on** Output 1 is on any time the TempTrac is enabled (Alarms will not disable). On power loss, this contact will be open, and when the TempTrac displays OFF, this will contact will be open. This is no longer a control output, and is not subject to alarms.
- Output 1, Spade terminals 4 & 5.
- Output 2, Spade terminals 6 & 7.
- Output 3, Spade terminals 8 & 9.

6.2 OUTPUT 1 CALL FOR HEAT (1on=rEG)

Kind of action: Heating

Reference probe: TP1

Terminals: SPADE 4 & 5

Related Parameters: St1, Hy1, LS1, US1, AC1, i3F, 1on

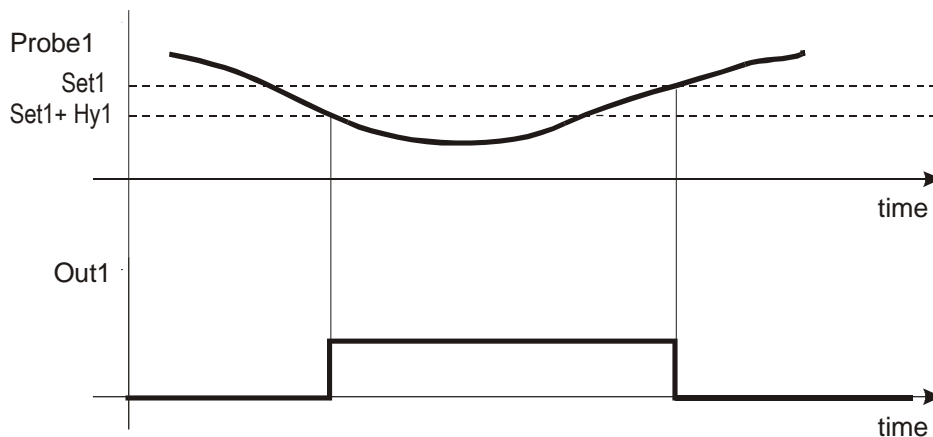

NOTES

- When probe 1 **TP1** falls below **St1**, a call for heat output will occur.
- Hy1** is the differential to prevent short cycling.
- When **Hy1** is negative, this will prevent the call for heat from starting until **TP1** falls below **St1 + Hy1**. The call for heat will continue until **TP1** reaches or goes above **St1**. See chart above.
- If **Hy1** is positive, then the call for heat will start when **TP1** falls below **St1**, and will stay active until **TP1** rises above **St1 + Hy1**. Not shown on chart.

6.3 OUTPUT 2 2ND STAGE (oS2=Std 2on=rEG)

Kind of action: Heating

Reference probe: TP1

Terminals: SPADE 6 & 7

Related Parameters: S2c, St2, Hy2, LS2, US2, AC2, oS2, 2on

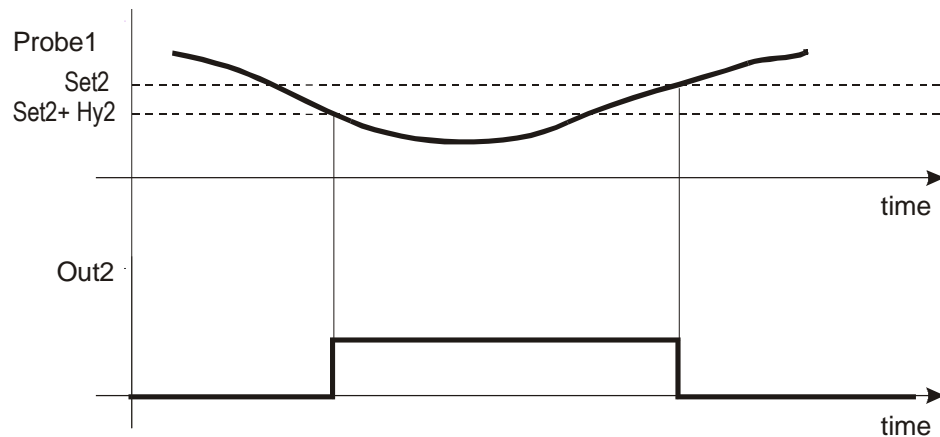

NOTES

1. Output 2 will function as an output temperature control when **oS2=Std**, otherwise output 2 is an alarm output contact.
2. **S2c** determines if **St2** is relative to **St1** or independent. (**S2c=dep** or **ind.**)
3. **Hy2** functionality same as **Hy1**. See [OUTPUT 1 CALL FOR HEAT](#).

6.4 OUTPUT 2 AS ALARM RELAY (oS2=AL, 2ON=REG)

1. Output 2 will function as an alarm contact when **oS2=AL**.
2. When an alarm condition occurs, Output 2 will be energized (relay closes) as an indication of an alarm condition.
3. **Terminals:** SPADE 6 & 7.

6.5 OUTPUT 3 TEMPERATURE PROTECTION (3on=rEG)

Kind of action: Heating

Reference probe: TP1 or TP2

Terminals: SPADE 8 & 9

Related Parameters: S3c, St3, Hy3, LS3, uS3, AC3, 3on, o3P

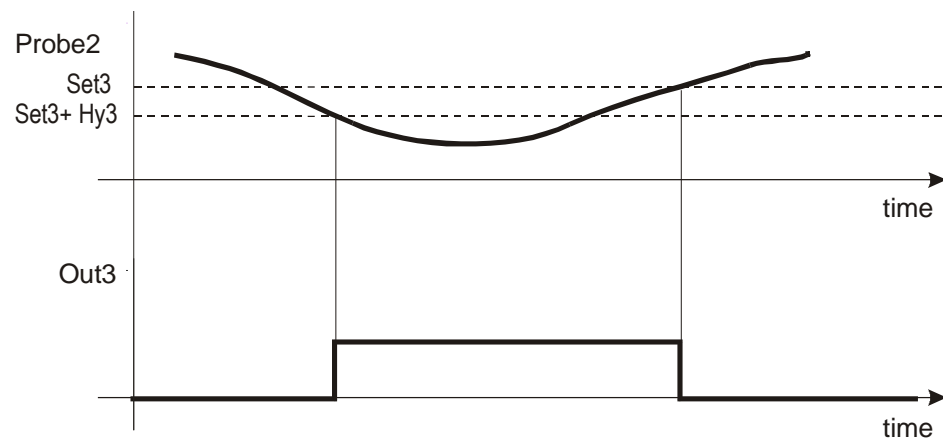

NOTES

1. Output 3 can be used to enable pumps when temperature falls below a St3.
2. o3P will select the probe for Output 3. Pb1 or Pb2.

6.6 OUTPUT 3 ALTERNATE SET POINT

Kind of action: Heating

Reference probe: TP1 or TP2

Related Parameters: St3, Hy3, LS3, US3, AC3, St5, Hy5, 3on, o3P, SSE, AC5, ACA

NOTES

1. When **SSE** is enabled and Output 1 is in a de-energized state (off) Output 3 will function according to **St3**. When Output 1 is in an energized state Output 3 will function according to **St5**.
2. **ACA** delays the change from **St3** to **St5**.
3. **o3P** selects temperature probe to be referenced by Output 3.
4. **Hy1**, **Hy3** and **Hy5** are active but not shown in this illustration.

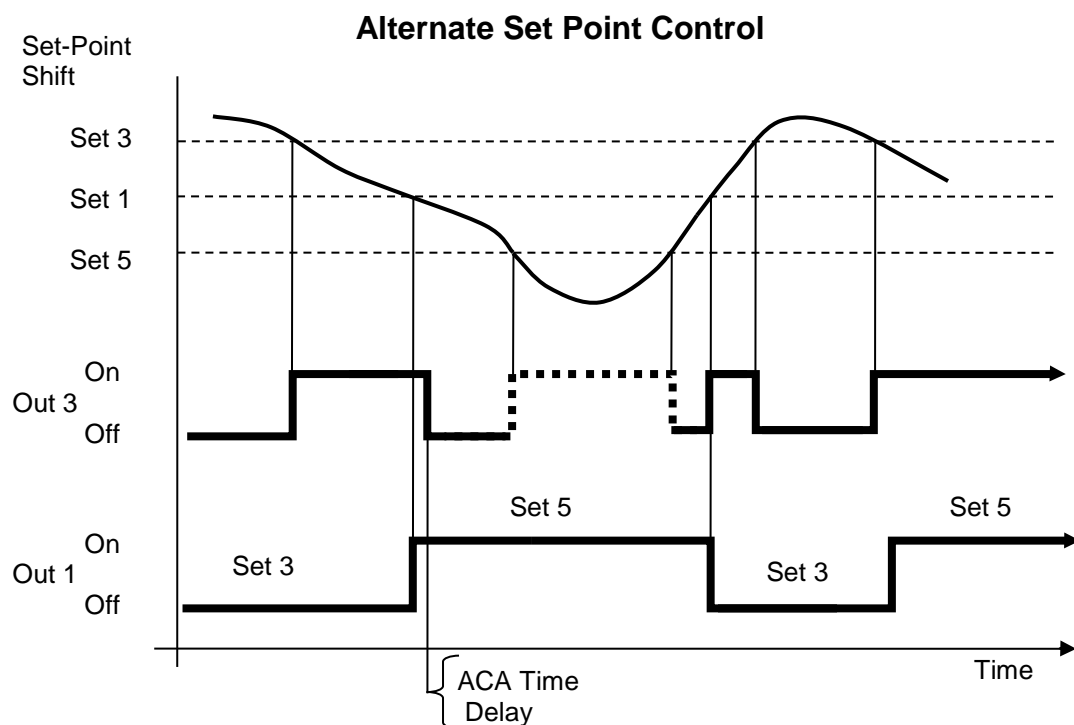

7. MODULATION OUTPUT

Kind of action: if $Sr < 0$ Heating; if $Sr > 0$ Cooling. See diagrams.

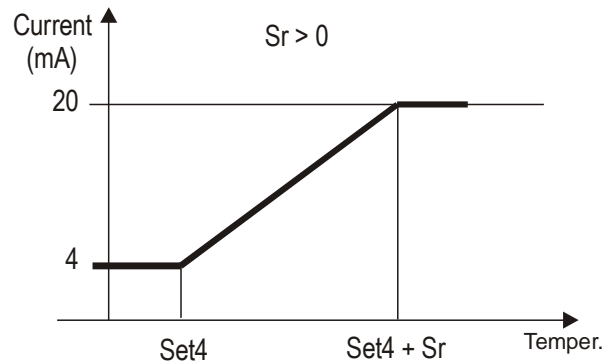
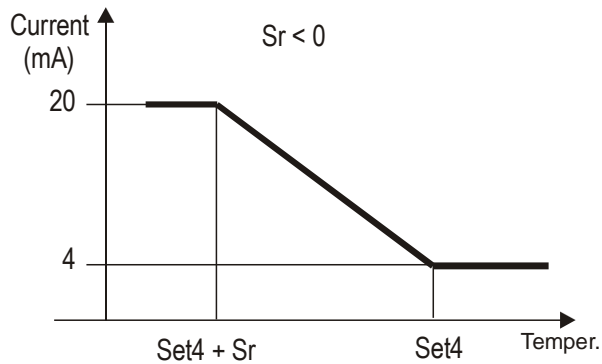

Reference probe: TP1

Related Parameters: S4c, St4, Sr, PS4, PP4, Ac4, i1S, i1t, i1F, i1d

NOTES

1. The kind of action of the modulation output depends on the sign of the **Sr** parameter.
2. If the parameter **PS4** is different from **nu**, the percentage of the modulation output depends on the value set in **PS4**, independently from the value of the probe. (0-100% represents 4mA to 20mA.)
3. If **i1F=No** and digital input 1 is ACTIVE, the analog modulation output is forced to the mA set in **i1S** parameter independently from the value of the probe and the value of the **PS4** parameters. After digital input 1 is no longer ACTIVE, the analog output will stay at the actual mA value set in **i1S** for the time period set by at the **i1t** parameter.
4. If the probe **TP1** is broken, **PS4=nu** and the digital input 1 is off, the value of the modulation output depends on the **PP4** parameter.
5. The value of the **PS4** parameter can be set directly by the keyboard. See par. 3.6.
6. Anti-short cycle delay for the analog output: when the analog output reaches the 4mA, it is held at 4mA for this time. During this time the  icon is flashing. When this delay has expired, normal functioning of modulation output restarts. This delay will be reinitiated again after output 1 switches off.
7. Ranges: **i1S** (4-20 range) is actual mA, **i1t** (0-30 range) is seconds. **PS4 & PP4** (0-100 & nu range) is percentage of output 0%=4mA 100%=20mA nu=AUTO.

8. MODULATION BUFFER

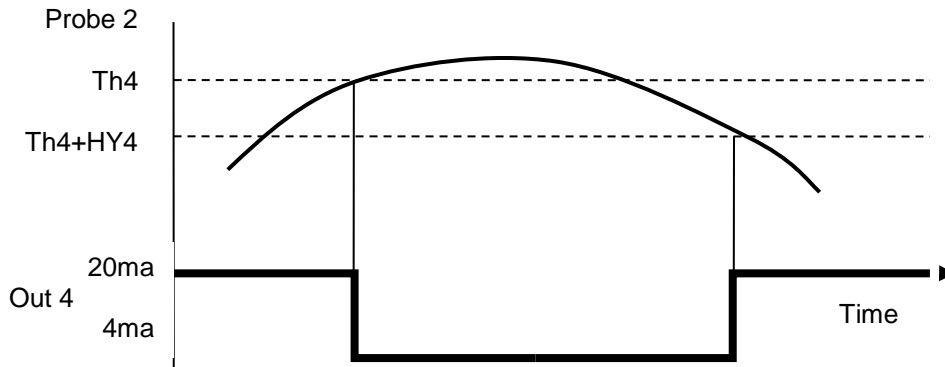

Kind of action: Heating

Reference probe: TP2

Related Parameters: Th4, HY4

NOTES

1. This function references probe **TP2** and will trigger output 4 to reduce the signal to 4mA when the temperature of **Th4** is reached by **TP2** and hold it until **TP2** drops below **TH4+HY4**. Output 4 then returns to normal operation referencing **TP1**.

9. DYNAMIC RESET OF St1

Kind of action: Inverse

Reference probe: TP3

Related Parameters: tt, rr2, St1, rr1

If the outdoor temperature is lower than **tt** the dynamic reset of the **St1** action starts as described in the following diagrams.

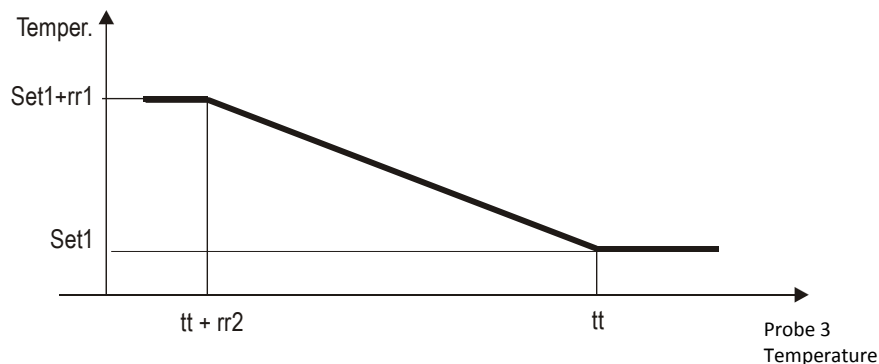

NOTES

1. With **rr1=0** the dynamic reset of the set point 1 is disabled.
2. If the **TP3** is not present (**P3P=no**) or broken, the dynamic reset of the set point 1 is disabled.

10. WARM WEATHER SHUT DOWN

The **tt2** parameter, referring to the outdoor probe TP3, establishes the upper threshold which all the relay outputs are open. Normal regulation restarts when **TP3 < tt2+Ht2**.

To disable this function set **tt2** to high a value. If the third probe is not present **P3P=no**, this function is disabled.



11. HOT KEY PROGRAMMING

To upload program from control to HOT KEY:



+



Insert HOT KEY into the TTL/HOT KEY connection on the back of the control. Press  and  keys together momentarily then press the  key. The **uPL** message will appear while uploading is occurring and the **End** message will appear when finished. Push any key to return to normal operation.

To download program from HOT KEY to control:





Press the **ON/OFF** key to turn off the control. Insert the HOT KEY into the TTL connection on the back of the control. Press the **ON/OFF** key again and downloading will begin. The **DoL** message will appear while downloading is occurring and the **End** message will appear when finished. Push any key to return to normal operation.

If **err** message is displayed during upload or download the programming failed. The cause of a failed program may be user error, faulty control or Hot Key.

12. ASSIGNING TEMPTRAC® ADDRESS FOR MODBUS RTU

The first step to interfacing a BAS (Building Automation Control) with a water heater or group of water heaters will be the assignment of the address number for each heater.



1. Enter the Programming mode by pressing the Set  and DOWN  key for 3s.
(lead with the SET key.)

2. Press the DOWN key.

3. Select “Pr2” – “PAS” parameter and press the “SET” key.

4. The value “0 - -” with a flashing zero is displayed.

5. Use UP or DOWN keys to input the Passkey in the flashing digit; confirm the figure by pressing “SET”. The Passkey is “321”.

6. Once you have entered the Pr2 menu press the DOWN key until the parameter **Adr** appears on the screen as shown to the right:



7. Now press the SET key once and the number will begin to blink. Use the arrow key to set the address. Each TempTrac on a RS-485 network must have a different address, to enable proper communication.

NOTE: The default for each TempTrac is Address #1. You can assign them to any number in the range of 1-247, this is the limitations of the MODBUS-RTU standard.



13. ALARMS

Alarm messages are displayed in the lower display of the TempTrac and are alternated with the default message. These alarm messages are displayed together with the icon devoted to signalling the alarm conditions.

Message	Cause	Outputs and information
"P1"	TP1 probe failure. Open or shorted	Audible alarm sounds. Output 1 and 2, if depending on the probe, open; modulation output, if depending on the probe, according to the PP4 parameter. Inspect probe 1; Screw terminals 14 & 17.
"P2"	TP2 probe failure. Open or shorted	Audible alarm sounds. Output 3 open. Inspect probe 2; Screw terminals 15 & 17.
"P3"	TP3 probe failure. Open or shorted	Audible alarm sounds. Dynamic reset of St1 disabled. Warm weather shut down disabled. Flue Gas Temperature Protection disabled. Inspect probe 3; Screw terminals 16 & 17.
"HA"	High-temperature limit set point exceeded	Audible alarm sounds, operation continues. see ALu .
"LA"	Low-temperature alarm	Audible alarm sounds, operation continues. see ALL .
"AL1"	Digital Input 1 ACTIVE and configured as Alarm	Opens Output 1. Subject to "need" for Output 1, and i1d . Automatic recover if the need for Output 1 is gone. With the loss of Input 1 signal, alarm is still active until a button is pressed. See i1F, i1P, i1d .
"AL2"	Digital Input 2 is ACTIVE for one or more of the conditions listed in section Audible Alarm	Audible alarm sounds. There is a time delay before this alarm is ACTIVE. Opens all temperature controlled outputs. Lockout condition. See oS2, i2d, i2P, i2F .
"AL3"	Digital Input 3 is ACTIVE for one or more of the conditions listed in section Audible Alarm	Audible alarm sounds. There is a time delay before this alarm is ACTIVE. Opens all temperature controlled outputs. Lockout condition. This is also the alarm for the ALMMB or ALOAF option code sometimes referred to as Alarm On Failure. See i3d, i3F, i3P .
"Nn1"	Maintenance alert for call-for-heat	Audible alarm sounds, operation continues. Maintenance Required; hours on ou1 exceed setting in oP1 . Clear ou1 ( Flashing).
"Nn2"	Maintenance alert for second stage	Audible alarm sounds, operation continues. Maintenance Required; hours on ou2 exceed setting in oP2 . Clear ou1 ( Flashing).
"Nn3"	Maintenance alert for freeze protection	Audible alarm sounds, operation continues. Maintenance Required; hours on ou3 exceed setting in oP3 . Clear ou1 ( Flashing).
"rtc"	The real time clock has lost its setting	Energy saving functions disabled. (Can occur after powered down for extended time.)
"rtF"	Real time clock failure	Energy saving functions disabled. (TempTrac® requires replacement.)

13.1 DIGITAL INPUT ALARMS

Digital Inputs

Polarity of the inputs is determined by the i1p, i2p, i3p parameters. If they are set to “CL” (closed) then a signal is present when the input terminal has a connection to the common (COM) terminal #21. When the parameter is set to “OP” (open) then a signal is present when the input terminal does not have a connection to the common (COM) terminal.

Digital Input 1 (Screw terminal #18, COM #21)

1. When a signal is continuously present for number of minutes in parameter **i1d**, the input is then ACTIVE.
2. When **i1F=Yes**, Digital input 1 is assigned to the alarm function and considered only when there is a need for Output 1.
3. When digital input 1 is ACTIVE, “**AL1**” will flash, and Output 1 will be disabled. Output 2 and 3 will continue to function.
4. This alarm will reset automatically if the need for Output 1 is removed (Probe 1 temperature rises above setpoint).
5. If **i1F=No** Digital Input 1 is not used as an alarm, but used as way method of forcing a specified modulation rate. See details about the **i1S** modulation function; refer to the [MODULATION Output](#) section of the manual.

Digital Input 2 (Screw terminal #19, COM #21)

1. When a signal is continuously present for number of minutes in parameter **i2d**, the input is then ACTIVE.
2. When **i2F=Yes**, Digital input 2 ACTIVE is considered only if Output 1 is energized.
3. When digital input 2 is ACTIVE, “**AL2**” will flash.

Digital Input 3 (Screw terminal #20, COM #21)

1. When a signal is continuously present for number of minutes in parameter **i3d**, the input is then ACTIVE.
2. When **i3F=No**, Digital input 3 ACTIVE functions as an alarm independent of output 1. “**AL3**” will flash for this condition.
3. When **i3F=Yes**, Digital input 3 ACTIVE functions as an alarm and is considered only if Output 1 is energized. “**AL3**” will flash for this condition.
4. When **i3F=Edi**, Digital input 3 ACTIVE de-energizes Output 1, and alarm conditions will not be registered in memory or indicated in any way until Digital input 3 deactivates. Note: no existing alarm indication will be shown until Digital input 3 state changes (neither an alarm icon, the **AL#** indication on the display nor the audible alarm activation). (This feature is still subject to the **i3d** timer.)

The Instrument will revert to normal operation when these digital inputs are disabled + any button is pressed.

13.2 AUDIBLE ALARM

The TempTrac audible alarm is activated each time a connected alarm condition occurs. The following are representative alarm conditions that may be connected to and activate the TempTrac audible alarm (some alarms may be connected to and operate separately from the TempTrac on some products).

- High/low water temperature alarm
- Probe failures
- External thermostat limit failure
- Flame Failure
- High and low gas pressure
- Low water

The audible alarm is silenced by pressing any key (alarm condition still present).

13.3 ALARM RECOVERY

1. Probe alarms: “**P1**”, “**P2**”, and “**P3**”; automatically stop a few seconds after the probe returns to normal operation. Check connections before replacing the probe.
2. Temperature alarms “**HA**” and “**LA**” automatically stop as soon as probe 1 temperature returns to **AFH** degrees below or above the alarm value respectively.
3. The digital input 1 alarm recovers automatically when the need for output 1 stops. Manual recovery is required when the condition of Input 1 is removed, but the need for output 1 is still present. Pressing any button will reset this condition.
4. The digital input 2 & 3 alarms recover when condition(s) listed above are normalized and any button is pressed.
5. RTC alarm stops after programming the real time clock.
6. RTF alarm requires the replacement of the TempTrac® device.

For additional information, contact the PVI Industries, LLC Customer Service department at 800-784-8326.