

INSTALLATION & MAINTENANCE MANUAL

EZ PLATE[®] INSTANTANEOUS WATER HEATER



Installation and service must be performed by a qualified service installer, service agency or qualified plumbing contractor.

IMPORTANT: THIS MANUAL CONTAINS INFORMATION REQUIRED FOR INSTALLATION, OPERATION AND MAINTENANCE OF THIS EQUIPMENT. READ AND FOLLOW THE INFORMATION IN THIS MANUAL AND ALL OTHER PROVIDED INSTRUCTIONS, LABELS AND MARKINGS BEFORE INSTALLING, OPERATING OR SERVICING THIS EQUIPMENT.



TO THE INSTALLER: After installation, these instructions must be given to the equipment user or left near the appliance.

SPECIAL INSTRUCTIONS TO THE OWNER: Retain this manual for future reference. These instructions contain important information that will help you in maintaining and operating this appliance.



A WATTS Brand

PVI INDUSTRIES, LLC - Fort Worth, Texas 76111 - Web www.pvi.com - Phone 1-800-433-5654

PV500-63 03/17

EZ PLATE WATER HEATERS

TABLE OF CONTENTS

- 1. Safety Considerations**
- 2. Product Description**
- 3. Water Heater Installation**
 - 3.1 Codes
 - 3.2 Electrical Requirements
 - 3.3 Checking Equipment Before you Install
 - 3.4 Service Clearances
- 4. General Piping Guidelines**
 - 4.1 Water Inlet / Outlet Connections
 - 4.2 Boiler Water Connections
- 5. Operating And Safety Controls**
 - 5.1 High Water Temperature Limit Control
 - 5.2 Temperature Control Valve
 - 5.3 Relief Valve Piping
- 6. Description of Operation**
 - 6.1 Optional Boiler Water Valve Package
 - 6.2 Boiler Water Temperature Controller
 - 6.3 Front Key Functions
 - 6.4 Changing the Temperature Controller Set Point (Operation Menu)
 - 6.5 Security Features
- 7. Startup Procedure**
 - 7.1 Pre-startup Inspection
 - 7.2 With All Product Valves Closed
 - 7.3 Operating Reminders
 - 7.4 Shut Down
- 8. Maintenance**
 - 8.1 Maintenance and Cleaning the Plate Heat Exchanger
 - 8.2 Temperature Control Valve
 - 8.3 Relief Valves
 - 8.4 Y-strainers
- 9. Troubleshooting Suggestions**

Warranty forms ship separately with each product.

1 SAFETY CONSIDERATIONS

WARNING: Do not use this appliance if any part has been under water. Immediately call a qualified service technician to inspect the unit and to replace any part of the control system and any other items affecting safe appliance operation and which has been under water. Failure to follow these instructions can cause property damage, personal injury, or exposure to hazardous materials or death.

IMPORTANT SAFETY NOTE

It takes only 5 seconds of skin contact with 140 °F water to cause a second degree burn! You must protect against high water temperatures at all lavatories, tubs, showers and other points of hot water contact.

Accidental scalding from high water temperatures is a greater risk in some types of installations. Some examples are:

**HOMES FOR THE MENTALLY OR PHYSICALLY HANDICAPPED
HOSPITALS AND NURSING HOMES**

ELDER CARE FACILITIES AND REST HOMES

ORPHANAGES AND CHILD CARE FACILITIES

OTHER INSTALLATIONS - WHERE RESPONSE TO CONTACT WITH HOT WATER MAY BE SLOWER OR WHERE THE DANGER OF HOT WATER CONTACT IS GREATER.

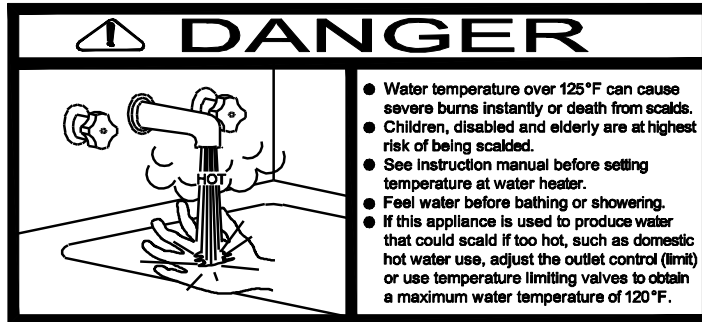

Thermostatically controlled mixing valves must be used in the design of the potable hot water system. Potable hot water should be tempered to no more than 110°F when used for bathing or other personal uses.

Good engineering practice mandates the use of thermostatically controlled mixing valves set at 120°F or less to keep the delivered water temperature below scalding temperatures.

EZ PLATE WATER HEATERS

2 PRODUCT DESCRIPTION

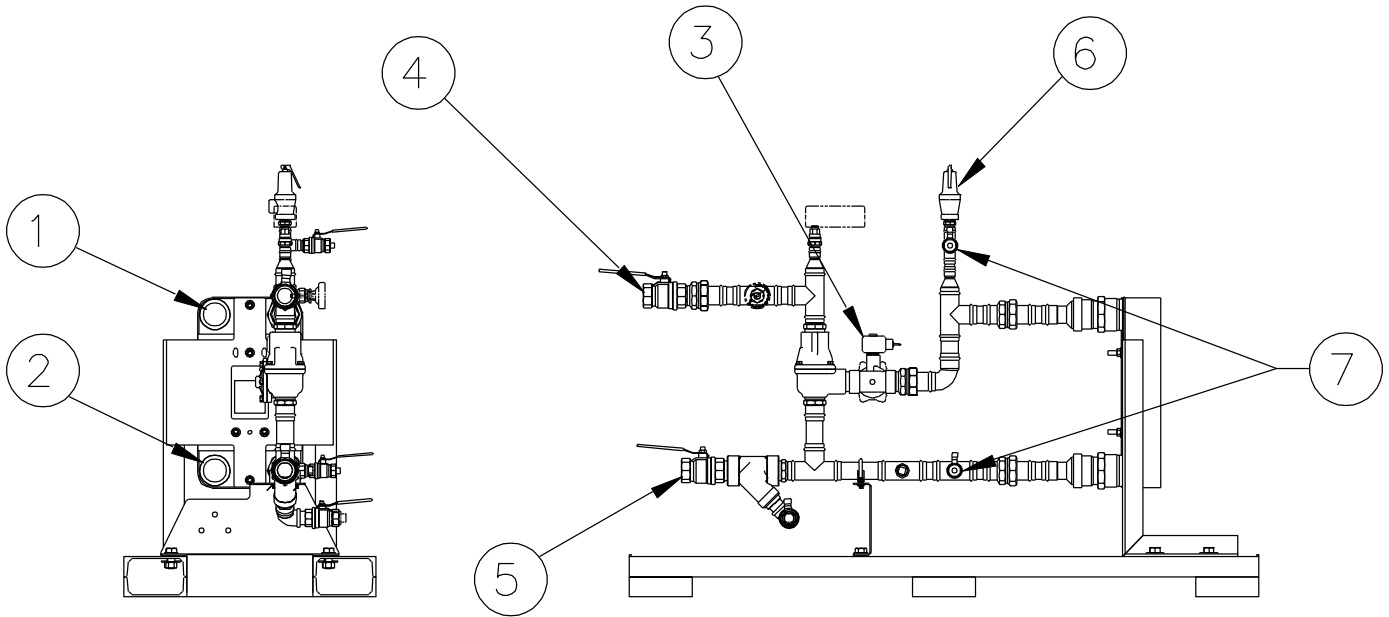

Typical EZ Plate Instantaneous Construction

- | | |
|-------------------------|--------------------------|
| 1. Boiler Water Supply | 5. Cold Water Inlet |
| 2. Boiler Water Return | 6. Pressure Relief Valve |
| 3. Safety Shutoff Valve | 7. Clean In Place Port |
| 4. Hot Water Outlet | |

NOTE: Components, controls and connection locations may vary.

EZ PLATE WATER HEATERS

3 WATER HEATER INSTALLATION

3.1 Codes

The equipment must be installed in accordance with the instructions in this manual, appliance markings and supplemental instructions and in compliance with those installation regulations in force in the local area where the installation is to be made. These must be carefully followed in all cases. Authorities having jurisdiction must be consulted before installation is made. In the absence of such regulations, the installation must be in accordance with the instructions in this manual, appliance marking and supplemental instructions and in compliance with the latest edition of the applicable state and local mechanical and plumbing codes.

3.2 Electrical Requirements

This appliance is wired for 120-volt service. The appliance, when installed, must be electrically grounded in accordance with the requirements of the authority having jurisdiction or in the absence of such requirements, with the latest edition of the National Electrical Code ANSI/NFPA No. 70. When the unit is installed in Canada, it must conform to the CAE C22.1, Canadian Electrical Code and/or Local Electrical Codes.

- Supply 15 amp, 120V service to each water heater. Separate electrical circuits are recommended for multiple appliance installations.
- All wiring between the unit and field installed devices must be made with type T copper wire of proper size for the appliance load. Damage resulting from use of aluminum wiring is not covered by the product warranty.
- Line voltage wire exterior to the appliance must be enclosed in approved conduit or approved metal clad cable.

3.3 Checking Equipment Before You Install

Inspect the unit completely upon receipt from the freight carrier before signing the bill of lading. Inspect the appliance and all accompanying parts for signs of impact or mishandling. Verify the total number of pieces shown on packing slips with those actually received. Contact the freight carrier immediately if any damage or shortage is detected.

1. Confirm that the system utilities are adequate to meet the heater requirements on the decal.
2. These units are suitable for indoor installation only.
3. The appliance must be placed on a level floor or housekeeping pad.
4. Do not attempt to move or lift heater by the plumbing connections or heat exchanger. Lift only by the skid using industry standard safe rigging methods.
5. Locate the unit so that if water connections should leak, water damage will not occur. Water damage is not covered by the manufacturer's warranty.
6. Units and associated electrical components and electrical connections, must be installed so they are protected from water (dripping, spraying, rain, etc.) during appliance operation and service.
7. In hard water areas, potable water treatment should be used to reduce introduction of minerals into the system. Minerals in the water can collect on the plates and heat-exchanger surfaces reducing the life of the product. Heat exchanger failure due to scale accumulation is not covered by the product warranty.

3.4 Service Clearances

A minimum clearance of 18" is recommended on all sides and above the appliance to facilitate easy access for inspection and service of installed components. Optional equipment may increase the clearance requirements.

Also allow sufficient space for installing and servicing building water, electrical, pump and other auxiliary/optional equipment and connections.

EZ PLATE WATER HEATERS

4 GENERAL PIPING GUIDELINES

WARNING: All system piping to the heat exchanger plumbing must be adequately supported. Failure to provide adequate support will result in excessive loads on the heat exchanger connections that can cause hot water discharge resulting in property damage, scalding and personal injury or death.

4.1 Water Inlet / Outlet Connections

IMPORTANT: Boiler and domestic water plumbing must be supported so that the EZ Plate water heater is not supporting any piping weight. If there is weight put on the plumbing connections, it could lead to corrosion of the heat exchanger or mechanical damage to the system that is not covered by the product warranty.

1. Connect the domestic water inlet and outlet to the potable system. Use backup wrenches on all threaded pipe connections to prevent damage to the heater plumbing. Piping and components connected to the water heater must be suitable for potable water, for the water temperatures they will experience and for their application.
2. For ease of service, install unions and shutoff valves on inlet and outlet piping to the unit.
3. The EZ Plate water heater must be connected to a building recirculation system with a pump capable of maintaining a minimum flow rate of 4 gpm through the EZ Plate water heater at all times. Connect the building hot water recirculation return line directly to the cold water inlet of the heater.
4. Fix any system leaks. DO NOT use stop-leak products. All system leaks must be repaired.
5. After plumbing the unit and checking for leaks, the heat exchanger and hot water piping should be insulated. Insulation will reduce wasteful heat loss, will help protect operators from contacting hot surfaces and is required to comply with ASSHRAE 90.1 and most state and local codes.

WARNING: Insulate or guard all surfaces containing hot water. Uninsulated or unguarded surfaces containing hot water can be hot enough to cause severe burns instantly, if contacted. Failure to insulate or guard all surfaces containing hot water can result in property damage, personal injury, or death.

4.2 Boiler Water Connections

IMPORTANT: Boiler and domestic water plumbing must be supported so that the EZ Plate water heater is not supporting any piping weight. If there is weight put on the plumbing connections, it could lead to corrosion of the heat exchanger or mechanical damage to the system that is not covered by the product warranty.

1. All boiler and domestic water supply lines should be flushed before connecting the unit. Failure to flush lines could cause components of unit to malfunction
2. The supply boiler, water heater and plumbing must be adequately sized in order to provide the necessary heat recovery. Consult PVI for assistance in sizing water heating equipment.
3. A Y-strainer with a blow-down valve piped to a suitable drain must be installed in the boiler supply piping near the appliance.
4. An air separator must be installed in the boiler piping near the appliance inlet.
5. Insulate or guard all surfaces and pipes containing hot water.

WARNING: Insulate or guard all surfaces containing hot water. Uninsulated or unguarded surfaces containing hot water can be hot enough to cause severe burns instantly, if contacted. Failure to insulate or guard all surfaces containing hot water can result in property damage, personal injury, or death.

EZ PLATE WATER HEATERS

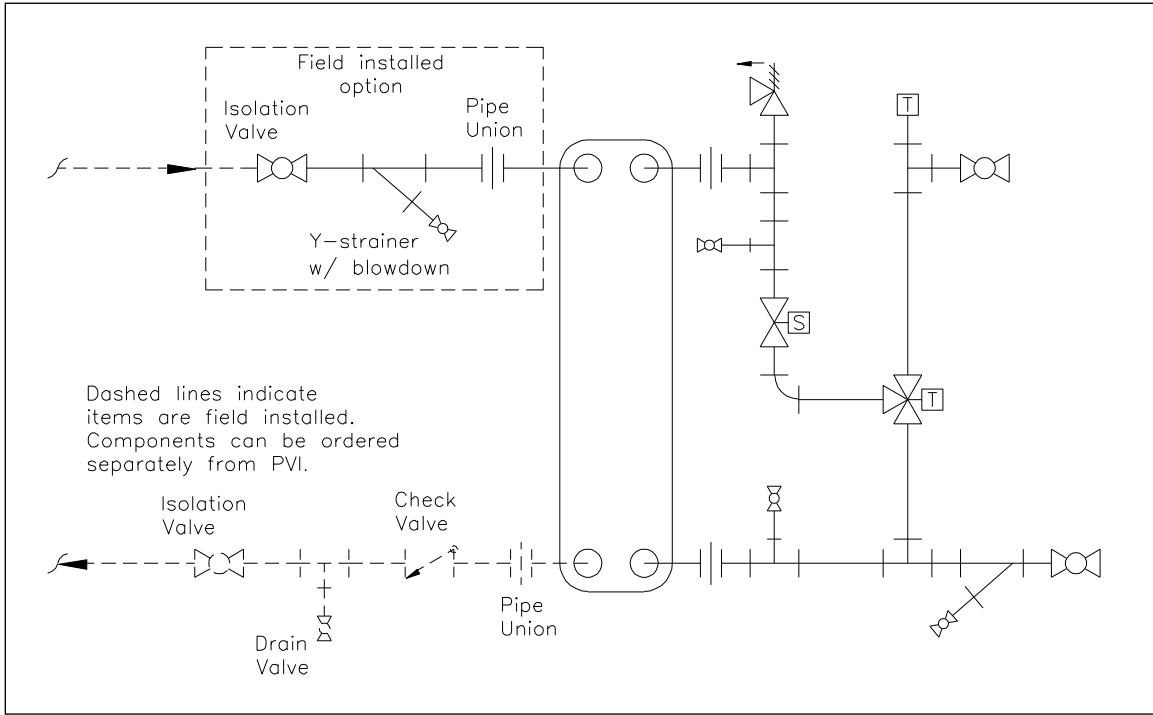



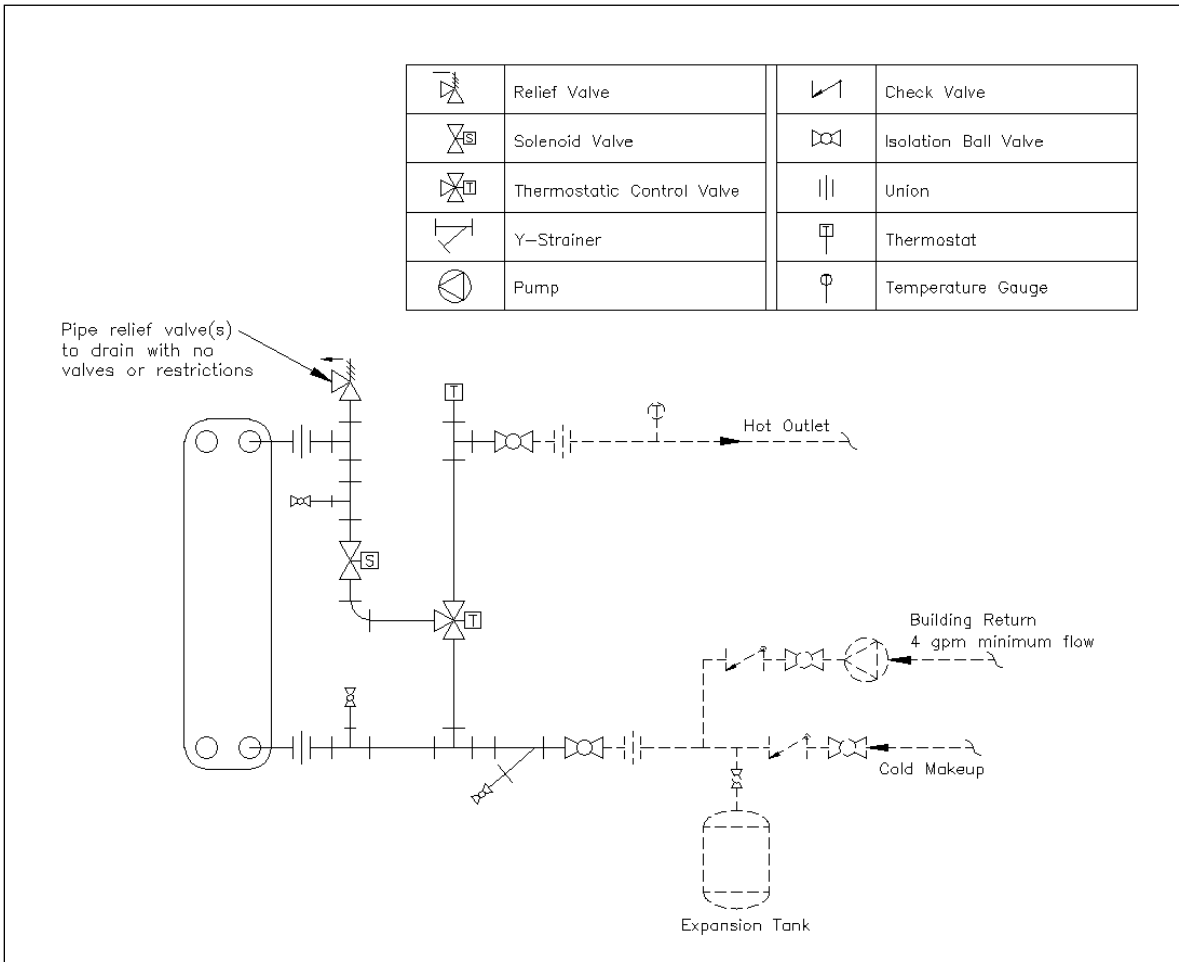







Typical EZ Plate Boiler Piping Layout



Typical Single EZ Plate Plumbing Layout

EZ PLATE WATER HEATERS

	Relief Valve		Check Valve
	Solenoid Valve		Isolation Ball Valve
	Thermostatic Control Valve		Union
	Y-Strainer		Thermostat
	Pump		Temperature Gauge

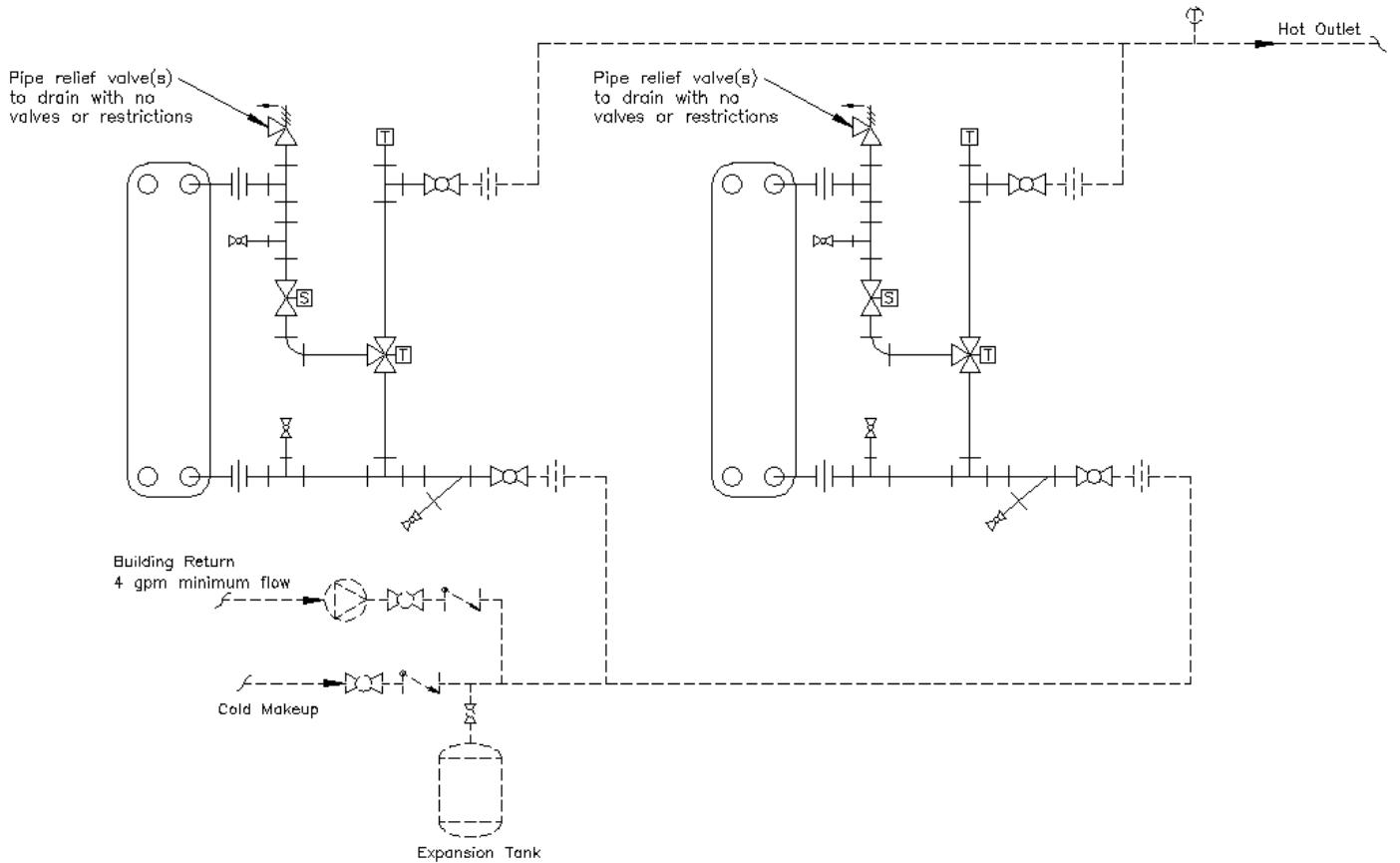

**Typical Dual EZ Plate Plumbing Layout
(Requires Balanced Reverse Return Piping)**

EZ PLATE WATER HEATERS

5 OPERATING AND SAFETY CONTROLS

WARNING: High Voltage Shock Potential - Turn off all electrical service to the appliance prior to opening any water piping or accessing any controls, components and wiring and fasten and close all water piping and electrical controls, components and wiring before restoring electrical service to the appliance. If the electrical service is not turned off and these points are wetted or touched, a dangerous shock can occur which can result in property damage, personal injury or death.

5.1 High Water Temperature Limit Control

The appliance is equipped with an adjustable temperature limit control. The adjustable limit control is a manual reset type and should be adjusted at least 10 degrees above the operating temperature of the appliance. It cannot be reset until the water temperature has dropped below its reset point.

5.2 Temperature Control Valve

The non-adjustable thermostatic valves are fully automatic, 3-way fluid temperature control valves. The valve is supplied with the temperature element assemblies factory-set to the nominal temperature setting. Temperature is sensed at Port A which remains open to Port B (bypass) until the fluid temperature reaches a point 5 - 10°F below the nominal setting. As the temperature continues to rise, the sliding valve moves to close off Port B and open Port C (connected to the heat exchanger). Port B is fully closed 8 - 10°F above the nominal setting. The valve continually modulates the fluid flow to maintain the nominal temperature.

5.3 Relief Valve Piping

EZ Plate water heaters are supplied with pressure relief valves for each heat exchanger sized in accordance with ANSI/ASME Boiler and Pressure Vessel Code, Section IV. The relief valve(s) must be threaded directly into the dedicated relief valve fitting located near the top of the heat exchangers and the relief valve discharge must be plumbed to an appropriate floor drain. The discharge line must allow complete drainage of the valve and line.

The water heater must not be operated without a correctly installed, properly sized and properly operating relief valve. If a replacement relief valve is required, it must be of the same type, pressure rating, and relieving capacity as the original equipment supplied with the water heater.

A relief valve that discharges periodically may be caused by the thermal expansion of heated water when restricted by a backflow preventer or check valve installed in the cold water supply. A means to control thermal expansion must be provided by a qualified plumbing professional. Do not plug the relief valve. Plugging the relief valve will eliminate the critical water temperature and pressure protection it is designed to provide.

WARNING: Do not install a reducing coupling, valve or other restriction between the relief valve discharge and a suitable floor drain. Such restriction could prevent the valve from fully relieving if the pressure settings are exceeded, which could result in property damage, personal injury or death.

WARNING: Secure the relief valve piping to a suitable floor drain such that very hot water does not openly splash during a significant relief valve discharge. If the relief valve pipe is not routed and secured to a suitable drain, hot water discharge can result in property damage, scalding and personal injury or death.

IMPORTANT: Thermal Expansion - A relief valve that periodically discharges may result from thermal expansion, if the water heater is installed in a system closed by components, such as a backflow preventer or check valve in the cold water supply. These systems must be provided with means to control expansion. Contact a water heater or plumbing professional to resolve this situation.

EZ PLATE WATER HEATERS

6 DESCRIPTION OF OPERATION

IMPORTANT: For proper operation of the EZ Plate the water heater must be supplied with boiler water at a minimum of 20°F above the water heater thermostatic element set point, to a maximum of 180°F, and a minimum recirculation flow rate of 4 GPM.

Demand for hot water causes cold water to flow into the water heater. The cold water can take either of two paths; through the cold port of the thermostatic temperature control valve or through the plate heat exchanger. Cold water entering the exchanger is heated to within 5°F of the boiler water temperature on the opposite side.

Hot water exiting the heat exchanger enters the hot port of the temperature control valve. The valve is self-contained with the ability to modulate the flows of cold and hot water as required to maintain the outlet temperature which is determined by the temperature sensing thermostatic element inside the valve. Under all flow conditions, the domestic outlet water is controlled to within 4°F of the valve set point.

Outlet temperature is constantly monitored by a high-limit thermostat. In the event of an over-temperature condition, a solenoid valve will shut off the flow of water to the valve's hot port allowing water to flow only through the cold port of the valve. No boiler water valve is necessary to control domestic hot water temperature. An optional boiler water valve is available for installations with VFD controlled boiler pumps where variable flow to the heat exchanger is desired.

When there is no hot water demand, the boiler and domestic water sides of the heat exchangers in this water heating system reach thermal equilibrium, so it is constantly ready to provide hot water.

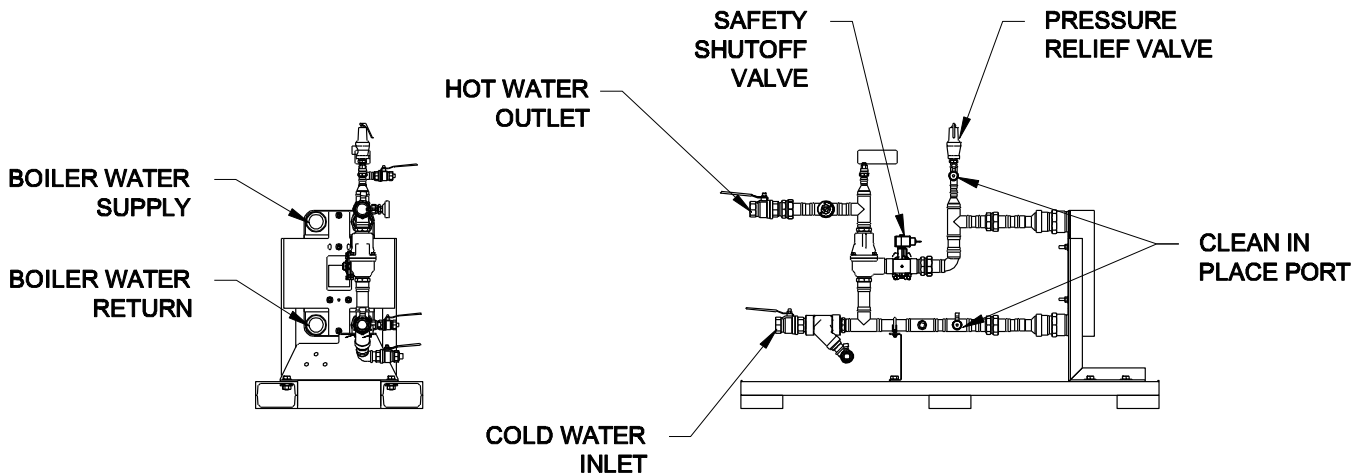

6.1 OPTIONAL BOILER WATER VALVE PACKAGE (150 psig, 220°F maximum)

The EZ Plate Boiler Water Temperature Control option package consist of three primary components: The Temperature Controller, 2 way Modulating Boiler Water Valve and Y-strainer.

When variable flow at the water heater is desired due to the operation of a VFD controlled boiler loop circulator, the EZ Plate can be configured with a modulating boiler water valve. In this configuration, blended domestic return water entering the water heater is monitored to position the boiler water control valve. The valve does not control the domestic hot outlet temperature, but only modulates boiler water into the heat exchanger as required. Domestic hot water outlet temperature is controlled by the thermostatic temperature control valve.

With no hot water demand, the temperature from the recirculation line will be the supply temperature minus the loop losses. This will allow the boiler water control valve to modulate to a minimum open position.

Any hot water demand will pull cold water into the valve line and mix the sensed temperature down. This lower temperature will be sensed by the temperature controller's sensing probe installed at the inlet and depending on the size of the change and the rate of change, the control valve will open to a position to allow the boiler water flow to match the demand. This is the feed-forward control.

The thermostatic temperature control valve in the system reacts to the change in its mixed temperature by pulling more from the hot port. This controls the outlet temperature to be at or near the thermostatic valve's thermal element set point.

EZ PLATE WATER HEATERS

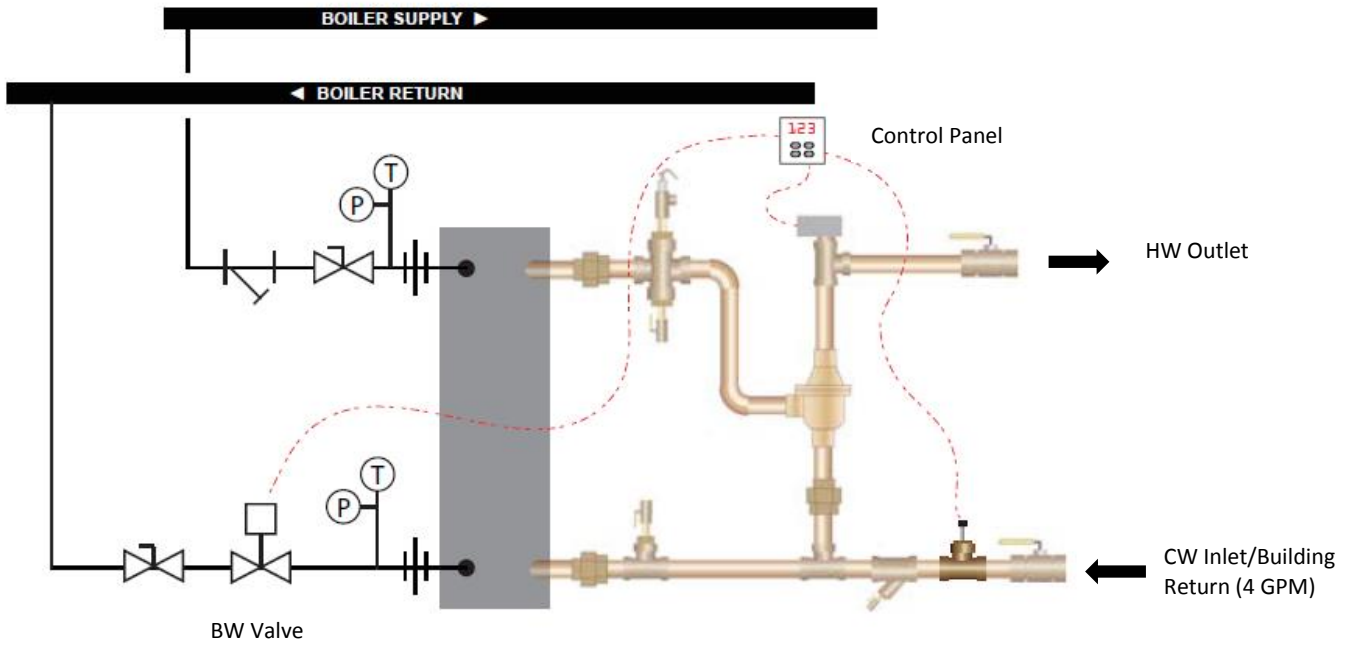





6.2 BOILER WATER TEMPERATURE CONTROLLER

The HOME display is the normal display while the control is operating. If no errors or functions are active, the default display of the **Upper Readout** is the domestic return water temperature sensed at the cold water inlet. The default display of the **Lower Readout** is the temperature controller's set point temperature.



EZ PLATE WATER HEATERS

6.3 FRONT KEY FUNCTIONS

	INDEX: Pressing the INDEX key advances the display to the next menu item.
	UP ARROW: Increments a value or changes a menu item. If pressed during the Operation Mode , the set point value will be increased.
	DOWN ARROW: Decrements a value or changes a menu item. If pressed during the Operation Mode , the set point value will be decreased.
	ENTER: Stores the value or item change. If not pressed, the previously stored value or item will be retained. When pressed during the Operation Mode , the controller switches to the Regulation Mode . If held for more than 3 seconds during the Operation Mode , the controller switches to the Initial Setting Mode . If pressed during the Regulation Mode or Initial Setting Mode, the controller will return to the Operation Mode .

6.4 CHANGING THE TEMPERATURE CONTROLLER SET POINT (OPERATION MENU)

The EZ Plate Instantaneous Water Heater's boiler water temperature controller ships with a factory set point of 120°F. To change the factory set point:

1. Press the **ENTER** and **INDEX** keys simultaneously to unlock the control.
2. Using the **UP** and **DOWN** Arrow keys, adjust the set point in the Lower Display to the desired control temperature. The value starts flashing in the lower display.
3. Press the **ENTER** key to confirm the set point value.
4. Press the **INDEX** key to cycle through the Operation Menu to reach the **LoC** parameter. The value in the Lower Readout should display **oFF**.
5. Press the **UP** arrow to cycle to the flashing **LoC1** value.
6. Press the **ENTER** key to lock the control and return to the Home screen.

INITIAL SETTING MENU (all parameters in this menu must be set before programming other values)

Press and hold the ENTER key for at least 3 seconds while at the Home Display in order to access the Initial Setting Menu. Pressing the INDEX key will cycle through the menu items. The parameter will be displayed in the top display, while its value will be displayed in the bottom display. The UP and DOWN arrows change the values of the parameters. The ENTER key must be pressed after any changes.

INITIAL SETTING MENU		
Parameter	Description	Value
<i>inPt</i>	Input Selection.	J2
<i>tPU_n</i>	Temperature Units.	F
<i>tP-H</i>	Scale Height Limit.	752.0
<i>tP-L</i>	Scale Low Limit.	-4.0
<i>Ctrl</i>	Control Mode.	PID
<i>S-HC</i>	Heat/Cool Selection.	HEAT
<i>ALR1</i>	Alarm 1 Setting.	0
<i>ALR2</i>	Alarm 2 Setting.	0
<i>C-SL</i>	Communications protocol language.	ASCII
<i>CoSH</i>	Communications Write Function Feature.	Off
<i>C-no</i>	Controller Address: Set from 1 to 247.	1
<i>bPS</i>	Baud Rate Setting.	9600
<i>LE_n</i>	Communication Data Length.	7
<i>P-rty</i>	Communication Parity Bit.	Even
<i>StoP</i>	Communication Stop Bit.	1

EZ PLATE WATER HEATERS

REGULATION MENU

Press the ENTER key while at the Home Display in order to access the Regulation Menu. Pressing the INDEX key will cycle through the menu items. The parameter will be displayed in the top display, while its value will be displayed in the bottom display. The UP and DOWN arrows change the values of the parameters. The ENTER key must be pressed after any changes.

REGULATION MENU		
Parameter	Description	Value
A_t	Auto Tune.	Off
P	Proportional Band Setting.	5
I	Integral time (reset time).	10
d	Derivative time (rate time).	0
I_{oF}	Integral Deviation Offset Correction.	0
$t_{P_{oF}}$	Process Temperature Offset.	0.0
L_{rH}	Analog Output High Limit.	0
L_{rLo}	Analog Output Low Limit.	0

OPERATION MENU

Pressing the INDEX key will cycle through the below menu items. The parameter will be displayed in the top display, while its value will be displayed in the bottom display, except for the set point which is displayed in the bottom display on the Home Display. The UP and DOWN arrows change the values of the parameters. The ENTER key must be pressed after any changes.

OPERATION MENU		
Parameter	Description	Value
$r-S$	Select Run - Stop Output Control.	Run
LoC	Set front panel security lock.	Loc1
oUt	Display the % output value for output 1.	0

After Setting LoC to Loc1, the control will no longer allow changes to the settings without following the unlocking procedures in the "Security Settings" of this guide.

6.5 SECURITY FEATURES

The temperature controller has two built in security lock settings to prevent unauthorized personnel from changing parameter settings. These parameters are set in the **Operation Mode**.

The LoC1 setting affects all parameters in the controller. If LoC1 setting is enabled, the operator will have to unlock the controller to make any changes to the controller's parameters.

The LoC2 setting affects all parameters except the set point. If LoC2 setting is enabled, the only parameter that the operator will be able to change is the set point. In order to change any other parameters, the operator will have to unlock the control before making a change.

In order to unlock the control, the operator must depress the ENTER and INDEX key simultaneously.

EZ PLATE WATER HEATERS

7 STARTUP PROCEDURE

7.1 Pre-startup Inspection

1. Confirm the domestic water supply pressure does not exceed the psi rating of the relief valve and the boiler water supply pressure does not exceed the heat exchanger pressure rating.
2. The hot water system must have a pumped recirculation line that will maintain a minimum of 4 gpm flow through the EZ Plate heater at all times.
3. Check all pipe fittings.

7.2 With All Product and Isolation Valves Closed Proceed As Follows:

1. Switch on power to unit to activate the solenoid valves and thermostats. The solenoid valve(s) should open.
2. Crack open the boiler strainer blow-down valve.
3. Check the set-point of the temperature limiting device near the hot water outlet. The limit device is located downstream of the thermostatic mixing valve near the hot water outlet. It must be set 10°F above the outlet water temperature element installed in the EZ Plate heater (e.g. if the outlet water temperature element is 120°F, the downstream limit set-point is 130°F).
4. Slowly open the domestic water supply valve to the EZ Plate heater. Check for water leaks on waterside piping. Crack open the domestic water outlet valve downstream of the EZ Plate heater to vent air from exchanger and piping. It may be necessary to open a hot water faucet downstream in the system. Continue venting air from the EZ Plate heater and piping, until a consistent flow of water is demonstrated.
5. Crack open the boiler supply to the heater and allow boiler water to flow through the boiler inlet strainer blow-down.
6. Slowly and fully open the main boiler shutoff valves.

IMPORTANT: Special attention should be paid to noise and leaks. Non-destructive water hammer (noise) is expected during startup. Extraordinary noise generation or leaking piping is reason to shut down the boiler water supply to the unit.

7.3 Operating Reminders

In order to achieve maximum performance from the heat exchanger, the following must be strictly followed:

1. Pressures and temperatures must not exceed limits on product decal.
2. Heat exchangers must be free of any debris existing in the water.
3. The system must be designed to prevent the heat exchanger from encountering pressure shocks.
4. Prevent rapid temperature increases in the heat exchangers. This would include installation of expansion tanks and safety valves into the system.
5. Prevent water in heat exchanger and piping from dropping below their freezing point.
6. A minimum of 4 gpm recirculation flow through the EZ Plate heater is required at all times.

7.4 Shut Down

1. Valve off the supply of boiler water to the heater.
2. Allow a flow of domestic water until it runs cold. Then shut off isolation valve at inlet of heater and then outlet.
3. Then disconnect electrical power.

EZ PLATE WATER HEATERS

8 MAINTENANCE

A preventative maintenance program should be established to assure a long, trouble-free life for the water heater.

WARNING: High Voltage Shock Potential - Turn off all electrical service to the appliance prior to opening any water piping or accessing any controls, components and wiring and fasten and close all water piping and electrical controls, components and wiring before restoring electrical service to the appliance. If the electrical service is not turned off and these points are wetted or touched, a dangerous shock can occur which can result in property damage, personal injury or death.

8.1 Maintenance and Cleaning the Plate Heat Exchanger

A scale of lime will normally form during operation and will accumulate inside the heat exchanger. Lime is formed from naturally occurring mineral compounds in the water, which precipitate out during heating cycles. Some water supplies contain more of these compounds than others and scale buildup will occur more rapidly. Other factors affecting the rate of scale buildup are the amount of hot water used and the temperature of the water. The more hot water used, the more fresh water with scale-forming compounds is brought into the heat exchanger. As the temperature of water increases, the rate of scale deposition will increase.

Debris or scale deposited in the heat exchanger will result in an increase in pressure drop, lower temperature difference on the waterside or a high exit temperature on the boiler water outlet. The frequency of cleaning will be determined by the rate of scale buildup. Until the appropriate cleaning interval is established, it is recommended that the heat exchanger be inspected and internally cleaned every six months or more frequently if there are higher scaling conditions. Flushing can be done without removal of the heat exchanger from the system by using the clean-in-place ports located in the hot water outlet and cold water inlet piping near the heat exchanger. Use only food grade cleaning agents.

When cleaning the heat exchanger, also inspect the plumbing to the temperature control valve for scale build-up. If necessary, de-scale those hot water surfaces.

8.2 Temperature Control Valve

The temperature control valve is factory set and not adjustable. It should be inspected and internally cleaned every six months or more frequently if needed. Replacement of the O-ring seal is recommended when the valve body is opened to access the thermostatic element for inspection or replacement.

The thermostatic element can be checked by immersing it in an agitated bath of water. Never use oil for checking the element. At 10°F to 13°F above the nominal setting, the bypass port B should be closed.

Replacement elements may be ordered from PVI. The element part number and nominal temperature setting are stamped on the flange of the element. If these are not known, provide PVI the complete model number and serial number on the valve nameplate. O-ring seals should be replaced whenever replacing elements. When installing or reinstalling seals, always lubricate them with light food grade plumbing grease to make installing of the element easier, and to prevent leakage from the housing.

8.3 Relief Valves

Relief valves should be manually operated at least once a year and if it fails to freely discharge water or fails to reseal following testing, it must be replaced with a like relief valve (see installation section for description).

8.4 Y-strainers

Periodically blow-down the valves on the y-strainers. If necessary, shutdown heater, remove and clean the mesh inside the strainer.

WARNING: Use caution and proper personal protection when opening blow-down valves. Discharge from the blow-down valves on the condensate y-strainers is extremely hot. Failure to use caution and proper personal protection when opening blow-down valves can result in property damage, instant scalding, other personal injury or death.

EZ PLATE WATER HEATERS

9 TROUBLESHOOTING SUGGESTIONS

Problem: **Outlet water temperature is not constant**

- a. **Cause:** Insufficient recovery

Solution: Verify heater rating is not exceeded.

- b. **Cause:** Recirculation inadequate

Solution: In certain conditions (usually at very low flow), inadequate system water recirculation can lead to unstable outlet water temperature. Confirm the recirculation pump is operating properly and is providing a minimum of 4 gpm flow through the EZ Plate heater at all times. Also confirm the EZ Plate heater hot water isolation valve and any other valves in the recirculation line are open.

- c. **Cause:** Failed temperature control valve.

Solution: Disassemble valve and replace temperature element and gaskets per valve manufacturer's recommendations.

Problem: **Outlet water temperature is below set point**

- a. **Cause:** Excessive flow rate

Solution: Water flow rate through heat exchanger surpasses its capacity. Check flow rate and compare with heater decal.

- b. **Cause:** Excessive scale in heat exchanger

Solution: Scale on heating surfaces impedes heat transfer. Inspect heat exchanger coil and schedule cleaning.

- c. **Cause:** Failed temperature control valve

Solution: Disassemble valve and replace temperature element and gaskets.

- d. **Cause:** EZ Plate heater hot water isolation valve closed

Solution: Fully open the EZ Plate heater hot water isolation valve.

- e. **Cause:** Solenoid valve closed

Solution: Indicated by low water temperature and lowered flow rate. Check if thermostats are open. If so, then an over temperature condition occurred. Shutdown unit and disassemble and inspect temperature control valves. If not, then solenoid valve has failed. Replace.

- f. **Cause:** Power failure

Solution: This closes the solenoid valve also causing loss of hot water pressure. Correct source of power loss.

- g. **Cause:** Insufficient supply of temperature or flow from boiler

Solution: Verify boiler loop operation.

- h. **Cause:** The high limit shutoff solenoid valve closed

Solution: If the high limit shutoff solenoid valve is energized, but is not open, service or replace the valve.

- i. **Cause:** The temperature limiting device is tripped

Solution: Confirm the limit device is set 10°F above the outlet water temperature element installed in the EZ Plate heater (e.g. if the outlet water temperature element is 120°F, the adjustable limit set-point is 130°F). If the adjustment is proper, but still tripped, confirm all other causes in this section are checked. If the other causes are confirmed and a temperature limit device is still tripped, replace the tripped device.

EZ PLATE WATER HEATERS

Problem: Low outlet water pressure

- a. **Cause:** Scale build-up in heat exchanger

Solution: Schedule cleaning of heat exchanger.

- b. **Cause:** Solenoid valve closed

Solution: Check if thermostats are open. If so, then an over temperature condition occurred. Shutdown unit and disassemble and inspect temperature control valves.

- c. **Cause:** Power loss

Solution: When there is no power to the unit, the high limit shut-off solenoid valve is closed.

Problem: Water leaking from the heat exchanger (for DW (double wall) EZ Plate)

- a. **Cause:** A continuous leak indicates one or more failed double wall heat exchanger plates. Confirm the water is not from an external source.

Solution: Replace heat exchanger. Replacement parts are available through your PVI Industries® Dealer. If you need assistance identifying or contacting your local dealer, you may contact PVI Industries, LLC directly at the address and telephone number located on the first and last page of this manual.

EZ PLATE WATER HEATERS

Since PVI cannot control the use of the appliance, water conditions, or maintenance, the warranty on the heat exchanger does not cover poor performance, structural failure, or leaking due to an excessive accumulation of scale

MODEL NUMBER: _____

SERIAL NUMBER: _____

INSTALLATION DATE: _____

PVI INDUSTRIES[®], LLC • 3209 Galvez Ave. • Fort Worth, Texas 76111 • Phone 1-800-433-5654 • www.pvi.com