

**AquaPLEX® Storage Tank (unlined duplex alloy)  
with EZ PLATE® Dual Boiler Water Heat Exchanger - Double-wall  
300 Gallon Tank Series - Dimensions**

Model No.	Amps @120V ①	A	B	C	Shipping Weight Lbs.
600-2 L 300A-TRBPDW	5	66	65	42	1395
900-2 L 300A-TRBPDW	5	66	65	42	1455
1200-2 L 300A-TRBPDW	5	66	65	42	1485
1800-2 L 300A-TRBPDW	7	66	75	42	1600
2400-2 L 300A-TRBPDW	7	66	75	42	1690
3000-2 L 300A-TRBPDW	7	66	75	42	1675
3600-2 L 300A-TRBPDW	11	63	72	42	1840
4500-2 L 300A-TRBPDW	11	63	72	42	1885
5400-2 L 300A-TRBPDW	13	67	85	51	2035

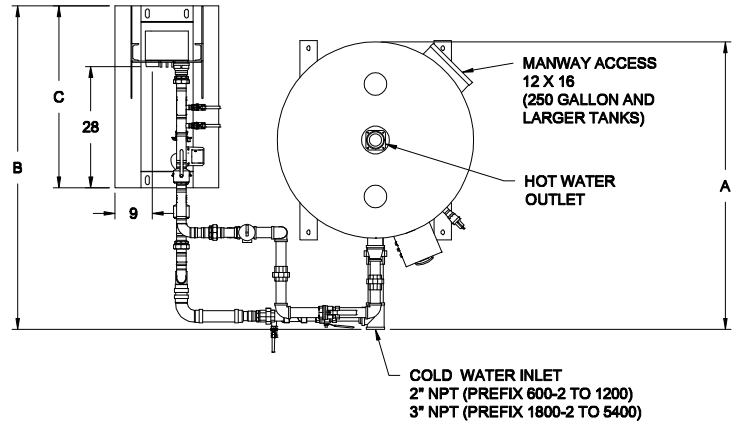

Refer to PV 8601, PV 8602 and PV 8603 for information on heat exchanger recoveries, pressure drop and boiler water flow requirements with various entering boiler water temperatures and domestic water temperatures.

Refer to PV 8600 for standard and optional equipment.

① Optional boiler water valve adds 2 amps total

Recommended service clearance is 18 inches on all sides.

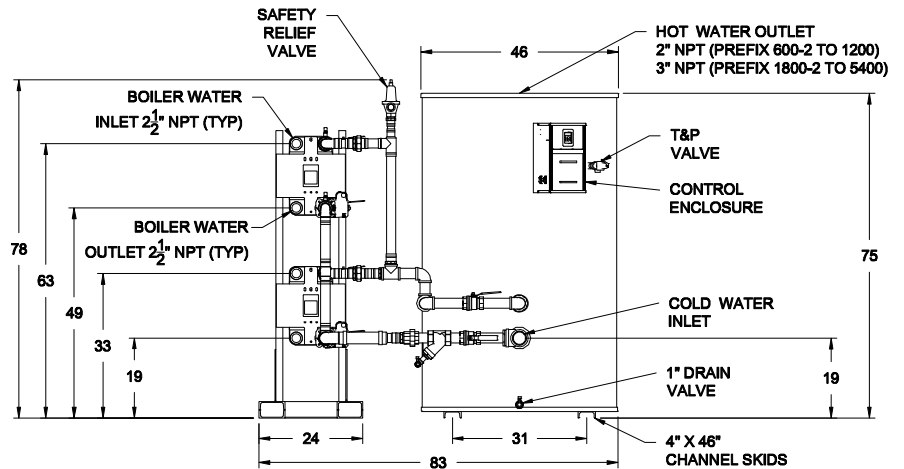

Completed piping assembly is factory fit between the exchanger and tank and separated at unions (or flanges) for shipping. Tank and heat exchanger ship separately for field assembly to piping assembly.

PVI reserves the right to change the design and specification without notice.

PV 8657 09-2019



PVI Industries, LLC  
Fort Worth, TX • (800) 784-8326 • www.pvi.com

