

## Installation, Operation & Maintenance Manual

---

### QuickDraw®

#### Storage and Semi-Instantaneous Steam Heater

**Important:** This manual contains information required for installation, operation and maintenance of this equipment. Read and follow the information in this manual and all other provided instructions, labels and markings before installing, operating or servicing this unit.

Installation and service must be performed by a qualified service installer, service agency or the gas supplier.



**To the installer:** After installation, these instructions must be given to the equipment user or left near the appliance.

**Special instructions to the owner:** Retain this manual for future reference. These instructions contain important information that will help you in maintaining and operating this appliance.



Manufacturing ASME Commercial Water Heaters Since 1961

# QuickDraw<sup>®</sup> Storage and Semi-instantaneous Steam Heater

## TABLE OF CONTENTS

- 1. Safety Considerations**
- 2. Product Descriptions**
- 3. Typical Piping Diagrams**
- 4. Water Heater Installation**
  - 4.1 Checking Equipment Before You Install
  - 4.2 Codes
  - 4.3 Electrical Requirements
  - 4.4 Location
  - 4.5 Installation
  - 4.6 Service Clearances and Clearance to Combustibles
- 5. General Guidelines**
  - 5.1 Water Inlet / Outlet Connections
  - 5.2 Steam & Condensate Connections
  - 5.3 Relief Valve Piping
  - 5.4 Steam Valves
  - 5.5 Filling the Unit
- 6. Operating and Safety Controls**
  - 6.1 Thermostat Settings – For QuickDraw Semi-Instantaneous Heaters only
  - 6.2 Operating Temperature Control
  - 6.3 High Water Temperature Limit Control
  - 6.4 Electronic Low Water Cut-Off (optional)
  - 6.5 Sequence of Operation
- 7. TEMPTRAC Electronic Controller Panel**
  - 7.1 Principle of Operation
  - 7.2 Upper LED Readout
  - 7.3 Lower LED Readout
  - 7.4 Control Buttons
  - 7.5 Key Combinations
  - 7.6 LED Icon Legend
  - 7.7 To View the Setpoint
  - 7.8 To Change the Setpoint
  - 7.9 To Set the Current Time and Day (Military Time)
  - 7.10 To Set the Energy Saving Time (Nighttime Setback)
  - 7.11 To Set Modulation Parameters
  - 7.12 To Change Other Parameters
  - 7.13 LED Display Alarm Messages
  - 7.14 Audible Alarm
  - 7.15 Alarm Recovery

# **QuickDraw<sup>®</sup> Storage and Semi-instantaneous Steam Heater**

- 8. Start-up Procedure**
- 9. Maintenance**
  - 9.1 Temperature and Pressure Relief Valve
  - 9.2 Thermostats and Temperature Limiting Device
  - 9.3 Steam Valve Actuator
  - 9.4 Tank
  - 9.5 Cleaning the Heat Exchanger
  - 9.6 Bolted Head Removal
  - 9.7 Recommended Maintenance Schedule
- 10. Troubleshooting Notes**

**Warranty forms ship separately with each product.**

# QuickDraw® Storage and Semi-instantaneous Steam Heater

## 1 SAFETY CONSIDERATIONS

### **IMPORTANT SAFETY NOTE**

*It takes only 5 seconds of skin contact with 140°F water to cause a second degree burn! You must protect against high water temperatures at all lavatories, tubs, showers and other points of hot water contact.*

**Accidental scalding from high water temperatures is a greater risk in some types of installations. Some examples are:**

**HOMES FOR THE MENTALLY HANDICAPPED  
HOMES FOR THE PHYSICALLY HANDICAPPED  
HOSPITALS AND NURSING HOMES  
ELDER CARE FACILITIES AND REST HOMES  
ORPHANAGES AND CHILD CARE FACILITIES**

**OTHER INSTALLATIONS - WHERE RESPONSE TO CONTACT WITH HOT WATER MAY BE SLOWER OR WHERE THE DANGER OF HOT WATER CONTACT IS GREATER**

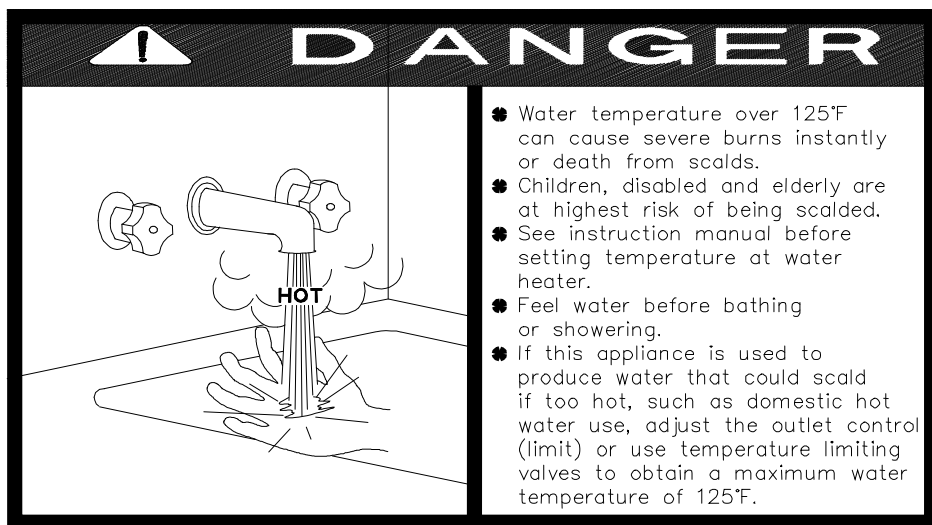

***Thermostatically controlled mixing valves must be used in the design of the potable hot water system.***

***Potable hot water should be tempered to no more than 110°F when used for bathing or other personal uses.***

***Good engineering practice mandates the use of thermostatically controlled mixing valves set at 120°F or less to keep the delivered water temperature below scalding temperatures.***

# QuickDraw® Storage and Semi-instantaneous Steam Heater

## 2 PRODUCT DESCRIPTIONS

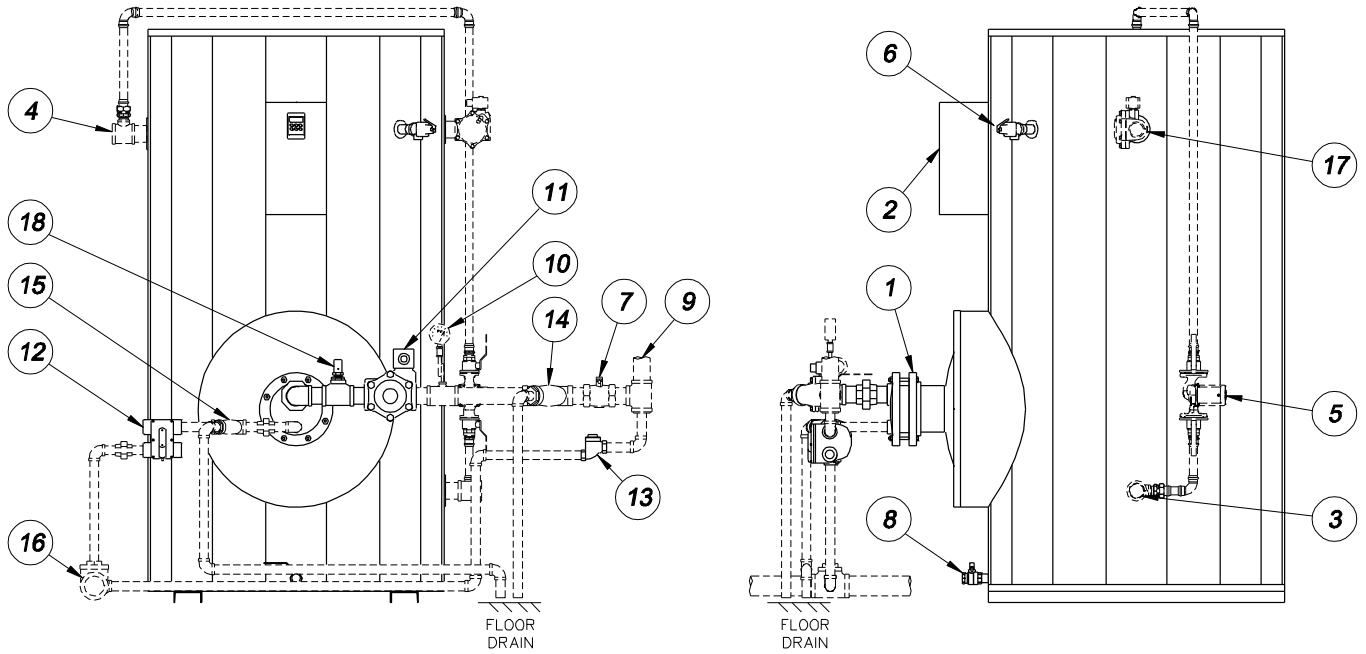

Typical QuickDraw® Storage Construction

- |                            |                              |
|----------------------------|------------------------------|
| 1. U-tube Heat Exchanger   | 12. Main Steam Trap          |
| 2. Control Enclosure       | 13. Auxiliary Steam Trap     |
| 3. Potable Water Inlet     | 14. Y-Strainer **            |
| 4. Potable Water Outlet    | 15. Condensate Y-Strainer ** |
| 5. Intra-tank Circulator * | 16. Condensate Drain **      |
| 6. Relief Valve            | 17. Tank Purge Valve *       |
| 7. Shutoff Valve **        | 18. Vacuum Breaker           |
| 8. Tank Drain Valve        |                              |
| 9. Steam Inlet             |                              |
| 10. Steam Pressure Gauge * |                              |
| 11. Steam Valve            |                              |

\* Optional

\*\* Supplied by Others  
(shown with dashed lines)

# QuickDraw® Storage and Semi-instantaneous Steam Heater

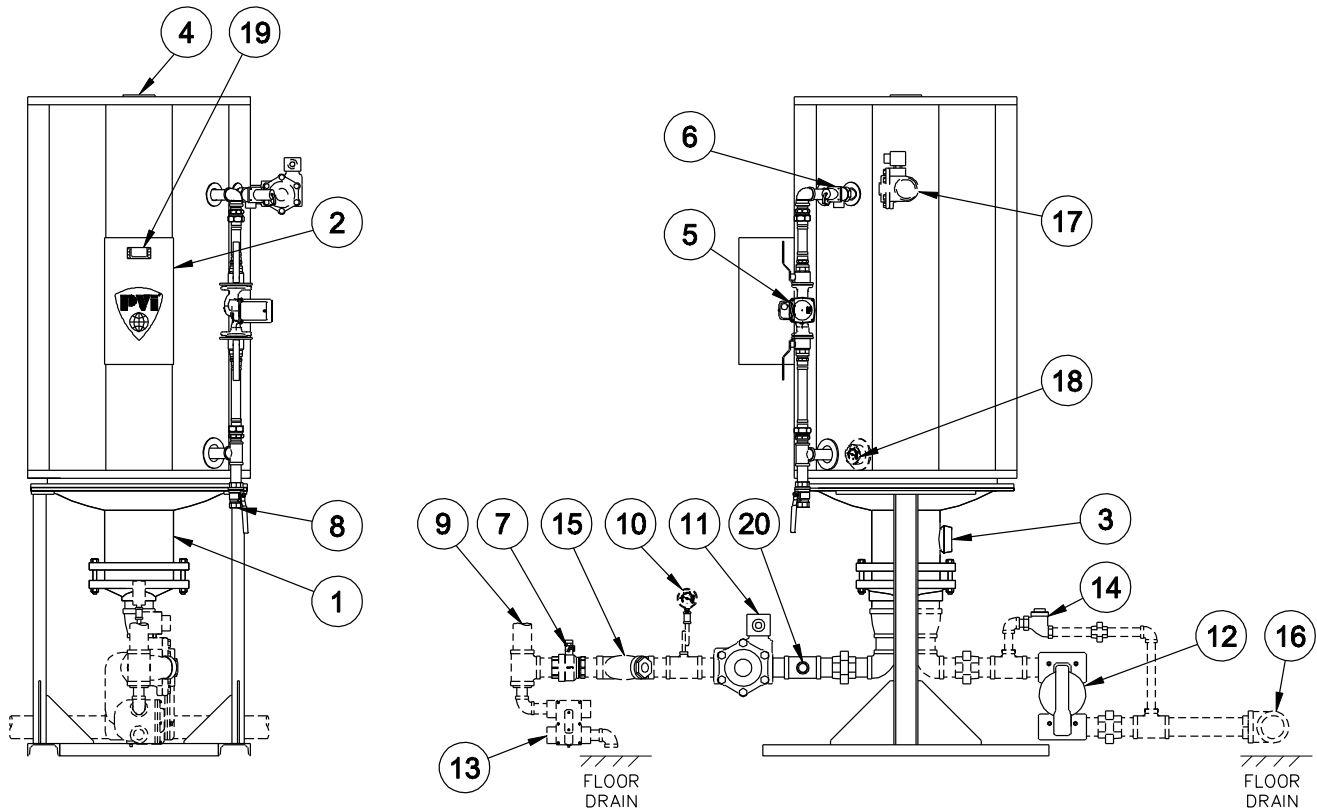

Typical QuickDraw® Semi-Instantaneous Construction

- |                            |                                  |
|----------------------------|----------------------------------|
| 1. U-tube Heat Exchanger   | 12. Main Steam Trap              |
| 2. Control Enclosure       | 13. Auxiliary Steam Trap **      |
| 3. Potable Water Inlet     | 14. Thermostatic Trap            |
| 4. Potable Water Outlet    | 15. Y-Strainer **                |
| 5. Intra-tank Circulator   | 16. Condensate Drain **          |
| 6. Relief Valve            | 17. Tank Purge Valve *           |
| 7. Shutoff Valve **        | 18. Tank Pressure Gauge *        |
| 8. Tank Drain Valve        | 19. Electronic Operating Control |
| 9. Steam Inlet             | 20. Vacuum Breaker               |
| 10. Steam Pressure Gauge * |                                  |
| 11. Steam Valve            |                                  |
- \* Optional  
\*\* Supplied by Others  
(shown with dashed lines)

**NOTE:** Components, controls and connection locations may vary.

# QuickDraw® Storage and Semi-instantaneous Steam Heater

## 3 TYPICAL PIPING DIAGRAMS

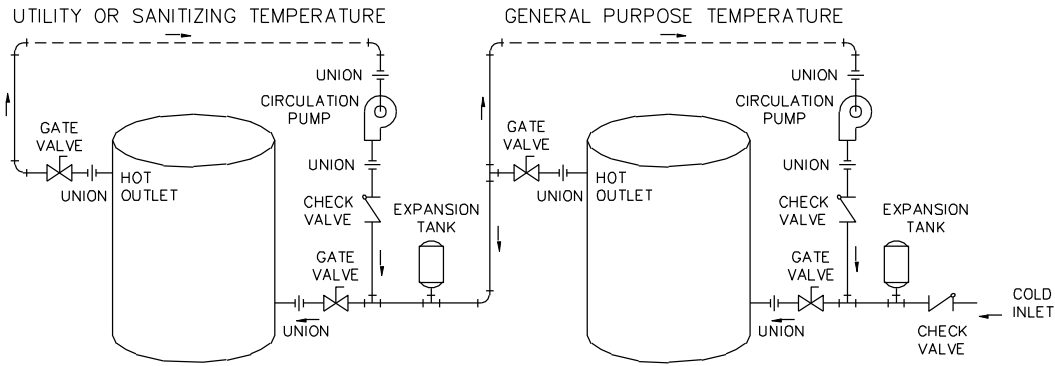

TWO TEMPERATURE SYSTEM  
GENERAL PURPOSE AND  
UTILITY/SANITIZING TEMPERATURE

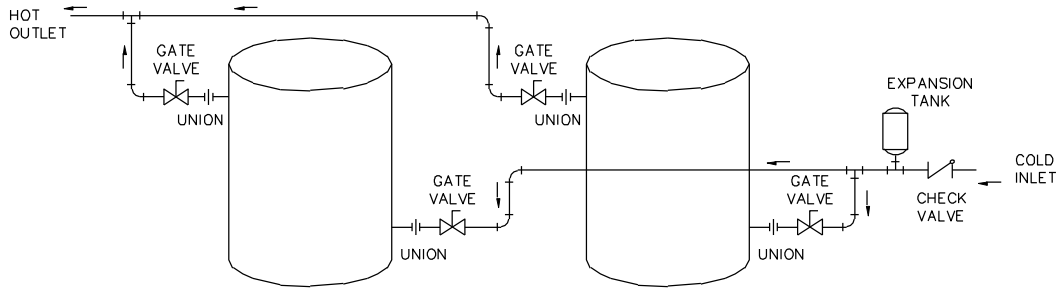

REVERSE DUOFLO MANIFOLD SYSTEM

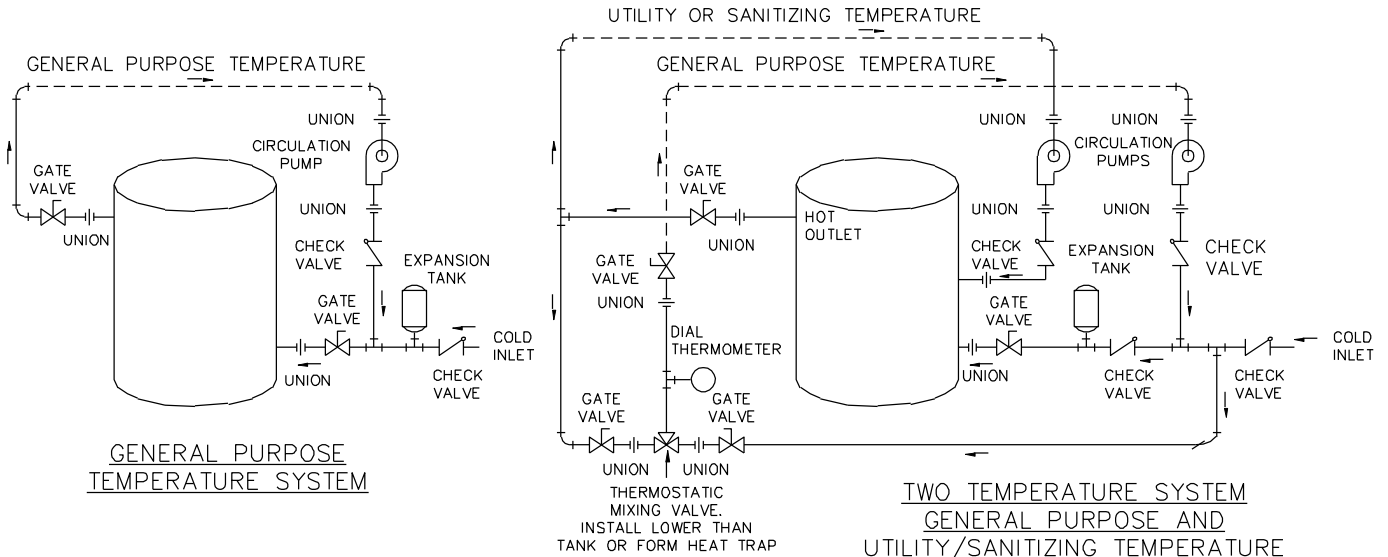

GENERAL PURPOSE  
TEMPERATURE SYSTEM

TWO TEMPERATURE SYSTEM  
GENERAL PURPOSE AND  
UTILITY/SANITIZING TEMPERATURE

# QuickDraw<sup>®</sup> Storage and Semi-instantaneous Steam Heater

## 4 WATER HEATER INSTALLATION

### 4.1 Checking Equipment Before You Install

Inspect the unit completely upon receipt from the freight carrier before signing the bill of lading. Inspect the appliance and all accompanying parts for signs of impact or mishandling. Verify the total number of pieces shown on packing slips with those actually received. Contact the freight carrier immediately if any damage or shortage is detected.

### 4.2 Codes

The equipment shall be installed in accordance with the instructions in this manual, appliance markings and supplemental instructions and in compliance with those installation regulations in force in the local area where the installation is to be made. These shall be carefully followed in all cases. Authorities having jurisdiction shall be consulted before installation is made. All appliances conform to the latest edition of the ASME Boiler and Pressure Vessel Code, Section IV, Part HLW or Section VIII.

### 4.3 Electrical Requirements

The heater is wired for 120VAC/1ph/60Hz volts and must be electrically grounded in accordance with local codes, or in the absence of local codes, with the latest edition of the National Electrical Code NFPA-70. When unit is installed in Canada, it must conform to the Canadian Electrical Code (CEC), CSA C22.1, and/or local electrical codes.

1. Branch circuit protection and disconnecting means must be furnished by the installer. Refer to the wiring diagram provided with this unit when installing or troubleshooting the electrical components of this heater.
2. All wiring must be in accordance with all local, state, or federal codes.
3. Provide proper overload protection for the system's circulating pump.

**NOTE:** Use only copper wire of proper sizing for incoming service. The warranty on this unit does not cover damage resulting from the use of aluminum wiring.

Utiliser du fil de cuivre de la taille appropriée pour le service électrique entrant. Les dommages résultant de l'utilisation de fil d'aluminium seront exclus du champ d'application de la garantie de cet appareil.

### 4.4 Location

1. Locate the unit in a clean and dry area as close as possible to the greatest hot water usage and as near to steam supply and/or electrical power as practical.
2. Install the unit on a firm, level foundation.
3. Locate the foundation on a pitched floor near a suitable drain, or make other provisions to prevent contact to areas of the building subject to water damage should steam or water connection leak. The drain must be sufficient to contain water in excess of 210°F.

### 4.5 Installation

**WARNING: Use industry standard safe rigging methods, such as including the use straps and spreader bars and lifting from the water heater base skid assembly, when attempting to lift or move this product. Failure to follow industry safe rigging methods could result in property damage, serious injury or death.**

1. Check the data decal on the heater. Be sure the electrical supply is adequate for the installation.
2. Carefully remove all shipping supports and bracing.
3. Do not attempt to move or lift heater by the plumbing connections or heat exchanger. Lift only by the skid using industry standard safe rigging methods.
4. Provide sufficient clearance in front of heat exchanger to facilitate maintenance and removal. See "Service Clearances" below.
5. Install shut-off valves and unions on the inlet and outlet water piping for servicing. Use caution when threading pipe nipples into tank connections to prevent cross threading, or over-tightening. Always use a back-up wrench on tank nipples when tightening unions, valves, etc.



# QuickDraw® Storage and Semi-instantaneous Steam Heater

6. Use only non-ferrous water piping and fittings for potable water plumbing and connections. Do not use galvanized pipe or fittings. Use of ferrous or galvanized pipe or fittings can cause rust to form.
7. Insulate hot water and return circulation lines. Also, if subject to freezing during shutdown or during operation, insulate all water piping and take whatever steps are necessary to keep the appliance and all water containing pipes and components from freezing. **IMPORTANT:** Do not use the plumbing connected to the appliance as a ground for welding or any other purpose.
8. This appliance is equipped with a temperature and pressure relief valve(s) rated for the input. The relief valve must be pipe to and attached to a suitable open drain (see Relief Valve Piping).
9. Pipe the drain valve to a suitable open drain.
10. Thermal Expansion Tank – If the water heater is installed in a closed water supply system, such as one having a back-flow preventer in the cold water line, provide thermal expansion control. Contact the water supplier or local plumbing inspector for additional information.

## 4.6 Service Clearances and Clearance to Combustibles

The appliance must not be installed on a combustible floor, or on a non-combustible floor covering combustible material. A minimum clearance of 6" must be provided from any combustible material. However, the recommended clearance is 24" at the top and front, 18" at left and right sides of the appliance. Optional equipment may increase the clearance requirements. Allow sufficient space for installing and servicing connections such as water, electrical, pump and other auxiliary equipment.

Distance minimale aux matériaux combustibles est de 15 cm sur le dessus et les côtés et ne doit pas être installé sur un plancher combustible.

## 5 GENERAL GUIDELINES

### 5.1 Water Inlet / Outlet Connections

1. Make inlet and outlet water connections directly to the threaded adapters provided. Over tightening connections to the provided adapters may cause damage to the adapters or tank and are not covered by warranty.
2. For ease of service, install unions on inlet and outlet piping to the unit.
3. Piping and components connected to the water heater must be suitable for potable water, for the water temperatures they will experience and for their application.
4. After plumbing the unit and checking for leaks, the heat exchanger and steam and hot water piping should be insulated. Insulation will reduce wasteful heat loss and will help protect operators from contacting hot surfaces.

**WARNING: Insulate or guard and hot water surfaces. Uninsulated or unguarded steam and hot water surfaces can cause burns instantly.**

### 5.2 Steam & Condensate Connections

1. The condensate trap controls the discharge of condensate based on the load on the heat exchanger, thus preventing the discharge of live steam through the unit. Appropriately sized traps are available from your PVI representative.
2. Connect the steam supply to the steam inlet fitting on the unit. A Y-strainer (100 mesh stainless steel sheet) must be installed ahead of the unit to prevent particles of scale and other solids from damaging the seats of the steam valve. It is good practice to install a blowdown valve on the Y-strainer piped to a suitable location that can be opened at intervals to clean the strainer screen. A condensate trap may be located upstream of the steam valve. This trap will drain the condensate that collects in the piping and must be plumbed to a suitable drain or the condensate receiver plumbing.

# QuickDraw® Storage and Semi-instantaneous Steam Heater

3. Connect condensate trap inlet parallel to or below the outlet of the heat exchanger. The ability to lift condensate via steam pressure cannot be assured on QuickDraw products due to the possible use of a modulating steam valve (storage units only) or multiple solenoid steam control system. The recommended methods of condensate distribution are:
  - a. Plumb to a condensate receiver and pump or vacuum return to the condensate return header.
  - b. Plumb to a pneumatic/electric actuated condensate pump trap for return to the condensate return header.
  - c. Drain to atmosphere – (would require constant make-up of boiler water).
4. Inadequate drainage of condensate can adversely affect heat transfer and limit the performance of the water heater. Please note damage to the water heater attributed to poor condensate drainage is **not** covered in the product warranty.
5. On the Quickdraw semi-instantaneous steam heater, the 3/4" thermostatic trap must be plumbed in parallel with the main steam trap for optimal operation of the heater. It speeds the removal of air from the heat exchanger when the steam valve opens. It also serves the second purpose of a vacuum breaker to protect the heat exchanger and allow proper drainage of condensate.
6. Locate the thermostatic trap in a tee six inches above the main condensate line between the heat exchanger and the main trap. Plumb its outlet to a point downstream of the main trap.

## 5.3 Relief Valve Piping

The water heater is supplied with a pressure and temperature relief valve, sized in accordance with ASME requirements. Each relief valve must be piped and secured to a suitable floor drain. No reducing coupling or other restriction can be installed in the discharge line. It is strongly recommended that this valve should be manually operated at least once a year. (See Maintenance.)

**WARNING: Do not install a reducing coupling, valve or other restriction between the relief valve discharge and a suitable floor drain. Such restriction could prevent the valve from fully relieving if the pressure settings are exceeded, which could result in property damage, personal injury or death.**

**WARNING: The relief valve discharge must be piped to a suitable floor drain to avoid exposure to hot discharge water during relief valve operation. Exposure to hot discharge water can cause water damage and/or burns resulting in property damage, personal injury or death.**

**WARNING: Secure the relief valve pipe to a suitable floor drain such that very hot water does not openly splash during a significant relief valve discharge. If the relief valve pipe is not routed and secured to a suitable drain, hot water discharge can result in property damage, scalding and personal injury or death.**

## 5.4 Steam Valves

Two position on-off electric valves are used. The valves will return to the closed position when power is off. This feature will prevent an excessive temperature buildup in the event of a power failure. The valve manufacturer's operation and maintenance instructions ship with the unit. Refer to these instructions during start-up and file for future referencing on maintenance.

**CAUTION:** Most valve problems are caused by dirt or trash in the steam line. This is most likely to occur during installation. Teflon pipe tape, pipe joint compounds, metal particles and dirt will clog up strainers and orifices and prevent valve seats from closing. Clean all pipe line strainers at start-up and check the valves again after a few days operation as recommended maintenance by the valve manufacturer. Inspection of strainers and blowdown piping should be part of the normal maintenance routine on this equipment.

## 5.5 Filling the Unit

1. Fill the system with water. To be sure that the unit is not "air bound," open the relief valve. Leave the valve open until a steady flow of water is observed. Close valve and complete filling the system.
2. In hard water areas, potable water treatment should be used to reduce introduction of minerals into the system. Minerals in the water can collect on the tubes and heat-exchanger surfaces reducing the life of the product. Heat exchanger failure due to scale accumulation is not covered by the product warranty.
3. Make sure there are no system leaks. DO NOT use petroleum based stop-leak products. All system leaks must be repaired.

# QuickDraw® Storage and Semi-instantaneous Steam Heater

## 6 OPERATING AND SAFETY CONTROLS

**WARNING:** Turn off all electrical service to the appliance when accessing the remote connections located inside the control cabinet and close and fasten the control cabinet cover before restoring electrical service to the appliance. Terminals and components in the control cabinet are high voltage. If the electrical service is not turned off and these terminals or components are touched, a dangerous shock can result in property damage, personal injury or death.

**Coupez l'alimentation avant intervention sur l'appareil.**

### 6.1 Thermostat Settings – For Quickdraw Semi-Instantaneous Heaters only

The adjustable operating temperature control is located just above the front control panel cover. This control utilizes a temperature sensing thermistor located in the control flange on top of the tank. Follow the safety instructions and warnings included in this manual and with the product, when adjusting the set point of the operating temperature control to deliver the desired water temperature.

The setpoint (SET) determines the desired stored water temperature in the tank and is factory set at approximately 120°F. If the tank temperature decreases below the set point a call for heat sequence is activated. The heating sequence is turned off when the tank temperature again reaches the set point value.

Le thermostat est réglé à environ 49 degrés Celsius. Températures de l'eau supérieures à 52 degrés Celsius peut causer instantanément de graves brûlures ou la mort de brûlures. Suivez les instructions dans le manuel d'installation et de maintenance pour modifier la température de l'eau.

#### To View The Setpoint

1. Press and quickly release the “SET” key. This will display the setpoint for 5 seconds.

#### To Change the Set Point

1. Press and hold the “SET” key for at least 2 seconds to enter the setpoint change mode.
2. The setpoint is displayed and the LEDs of the first and third digits blink.
3. To change the value, use the “UP” and “DOWN” keys.
4. The new value can be stored either by pressing the “SET” key (the control restores temperature display) or by waiting the exit time-out to expire (15 seconds).

#### Key Combinations

1. TO UNLOCK THE KEYBOARD: Press and hold the “UP” + “DOWN” keys for 3 seconds. When the “PON” flashing message is displayed, the keys are unlocked.
2. TO LOCK THE KEYBOARD: Press and hold the “UP”+ “DOWN” keys for 3 seconds. When the “POF” flashing message is displayed, the keys are locked.
3. TO RETURN TO TEMPERATURE DISPLAY: Press the “SET” +”UP” keys.

### 6.2 Operating Temperature Control

An adjustable digital operating control is located in the front control panel. The control is factory pre-set at approximately 120°F. To adjust the setpoint to deliver the desired water temperature, press and release the Set key on the face of the control. When setpoint adjustment is enabled, use the arrow keys to adjust the set point to the desired system temperature. See TempTrac Electronic Controller Panel in this manual for more information.

Le thermostat est réglé à environ 49 degrés Celsius. Températures de l'eau supérieures à 52 degrés Celsius peut causer instantanément de graves brûlures ou la mort de brûlures. Suivez les instructions dans le manuel d'installation pour modifier la température de l'eau.

### 6.3 High Water Temperature Limit Control

The appliance is equipped with an adjustable temperature limit control and a non-adjustable high temperature limit control. These controls are located inside the control cabinet and are accessed by removing the bottom cover.

The adjustable limit control is an auto reset type and should be adjusted at least 10 degrees above the set point of the Operating Thermostat.

The high limit is an auto reset type with a fixed set point, but is optionally available as a manual reset type. If the high limit is a manual reset type, it cannot be reset until the water temperature has dropped below its reset point.

# QuickDraw<sup>®</sup> Storage and Semi-instantaneous Steam Heater

## 6.4 Electronic Low Water Cut-off (optional)

When the water level is above the electrode position in the tank, the reset pushbutton will energize the control (LED will be lit). The control remains energized until the water level recedes below the electrode position (LED will not be lit). Unless otherwise specified, there is a three-second time delay on decreasing level. Water level must be below tank probe location for full three seconds before control de-energizes.

## 6.5 Sequence of Operation

1. When power is supplied through the unit's On-Off switch, if the stored water temperature is below the operating thermostat set point, the limit operating circuit closes creating a call-for-heat-demand, which energizes the actuator on the control valve.
2. On a call-for heat, the actuator motor runs and the actuator shaft extends causing the valve to allow steam through the heat exchanger.
3. When the demand is satisfied, the operating thermostat opens and the valve actuator is de-energized. The actuator motor stops running and the actuator shaft spring returns to the retracted position, which stops steam flowing through the heat exchanger.

# QuickDraw® Storage and Semi-instantaneous Steam Heater

## 7 TEMPTRAC™ ELECTRONIC CONTROLLER PANEL

### 7.1 Principle of Operation

The water heater operates to satisfy the setpoint of the TempTrac digital control whose sensor is located near the energy source of the water heater tank. Demand (flow) will typically create a drop in temperature, thus activating the water heater to add heat to the stored water. This setpoint is the desired water temperature to maintain.

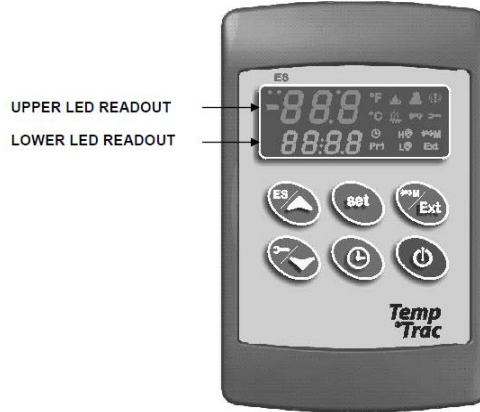

### 7.2 Upper LED Readout

The default display of the upper readout (Probe 2) is the water temperature near the hot water outlet.

This readout can display additional information by pushing the EXT button to cycle through the following items:

- The modulation rate of the valve, if applicable, indicated by 0 to 100%.
- The temperature difference between Probe 1 and Probe 2.
- All of the display information described above is available for monitoring through the optional MODBUS RTU interface.

### 7.3 Lower LED Readout

The default display of the lower readout (Probe 1) is the water temperature sensed near the middle of the water heater tank. This sensing location serves as the primary control temperature for the TempTrac.

### 7.4 Control Buttons

<b>SET</b>	Displays and modifies the temperature set points. In programming mode, it selects a parameter or confirms an operation.
<b>UP</b>	Displays and modifies the energy saving (Night Time setback) settings. In programming mode, it browses the parameter codes or increases a displayed value.
<b>DOWN</b>	Displays the working hours of the load relays. In programming mode, it browses the parameter codes or decreases a displayed value.
<b>CLOCK</b>	Changes lower display from the stored water temperature to current time and day.
<b>EXT</b>	Changes upper display from Probe 1 temperature to Probe 3 temperature, displays the temperature difference of the stored water temperature minus Probe 2 temperature and firing rate of the burner from 0 to 100%. In programming mode it sets the 4-20mA output (password is required).
<b>ON/OFF</b>	Switches the control ON or OFF.















(See TempTrac User Manual PV500-41 for full description)

# QuickDraw® Storage and Semi-instantaneous Steam Heater

## 7.5 Key Combinations

- Use the **UP + DOWN** key to lock and unlock the keyboard.
- Use the **SET + DOWN** arrow to enter the programming mode.
- Use the **SET + UP** arrow to exit the programming mode.

## 7.6 LED Icon Legend

LED	MODE	Function
°F	ON	Temperatures are displayed in degrees Fahrenheit
°C	ON	Temperatures are displayed in degrees Celsius
	Flashing	Call for heat time delay or remote enable/disable is in standby (disabled)
	ON	Call for heat is on
	Flashing	Second stage time delay (On 2-stage units only)
	ON	Second stage on or the <b>AL2</b> alarm output is enabled.
	Flashing	Output 3 time delay
	ON	Output 3 relay on
	ON	Modulation output signal is in manual control mode or forced to the <b>i1S</b> setting by digital input 1
	ON	Modulation output signal is automatically controlled by temperature probe 1
	Flashing	Modulation output time delay is activated.
<b>Ext</b>	ON	Probe 3 is displayed
	FLASHING	Digital input 2 (alarm) is activated
	FLASHING	Digital input 3 (alarm) is activated
	ON	Lower display is displaying the time
	FLASHING	Alarm signal
	FLASHING	Programmed working hours limit is exceeded
	ON	Working hours are displayed in Lower LED readout
ES	ON	The energy saving function is running

## 7.7 To View the Setpoint

- Push and release the **SET** key to see the set point value.
- To return to normal display, press **SET + UP** or wait 15 seconds without pressing any key.

## 7.8 To Change the Setpoint

- Push the **SET** key. The upper display will show the “St1” parameter name, while the lower display will show its value.
- Use the **UP** or **DOWN** key to cycle through the parameter names.
- Push the **SET** key to modify a parameter value. The value starts flashing in the lower display.
- To change it push the **UP** or **DOWN** keys. Push the **SET** key again to confirm the value and pass to the setting of next set point.
- Repeat the operations described at points 3, 4, 5.
- **To Exit:** press **SET + UP** or wait 15 seconds without pressing any key.

**NOTE:** Each point has a time out of 15 seconds. If any key is pushed within 15 seconds the controller exits the set points programming procedure.

**NOTE:** The set value is stored even when the procedure is exited by waiting the time-out to expire.

# QuickDraw® Storage and Semi-instantaneous Steam Heater

## 7.9 To Set the Current Time and Day (Military Time)

- Push and hold the **CLOCK** key for more than 3 seconds. The LED icon starts flashing and the “**Hur**” (hour) parameter name is displayed in the Upper LED readout, its value is displayed in the Lower LED readout.
- Pushing the **UP** or **DOWN** key alternates the LED readouts between the following:
  - “**Hur**” (hour) in the Upper readout and its value in the lower readout
  - “**Min**” (minute) in the Upper readout, its value in the Lower readout
  - “**dAY**” (day) in the Upper readout, its value in the Lower readout
- To adjust a value, press the **SET** key and the value in the Lower LED will start flashing. Change the value by pressing the **UP** or **DOWN** keys. When correct, press the **SET** key.
- To exit push **SET + UP** keys or wait 15 seconds without pressing any keys.

**NOTE:** This device recognizes Sunday as the first day of the week and Saturday as the last.

## 7.10 To Set the Energy Saving Time (Nighttime Setback)

- Push and hold the **UP** key for more than 3 seconds and the first parameter of the energy saving will be displayed.
- Use the **UP** or **DOWN** keys to browse them.
- To change a value, push the **SET** key followed by **UP** or **DOWN** and then the **SET** key again.
- To exit from the menu, press **SET** and **UP** or wait for 30 seconds.

## 7.11 To Set Modulation Parameters

- Push and hold the **EXIT** key for more than 3 seconds and the LED will switch **ON** and a passkey will be required to view and manually change the modulation % value. Passkey is “321”.
- Upon entering the password, the modulation % value will be displayed in the lower display.
- To manually adjust this value, push the **SET** key; the value will start flashing. Adjust it by using the **UP** or **DOWN** keys and then the **SET** key again.
- To exit from the menu, press **SET** and **UP** keys together or wait for 30 seconds.



## 7.12 To Change Other Parameters

- Push the **SET** and **DOWN** arrow simultaneously for 3 seconds.
- Select the required parameter. The name of the parameter is on the upper display; its value is on the lower display.
- Press the **SET** key: the value of the parameter will start blinking.
- Use **UP** or **DOWN** to change the value.
- Press **SET** to store the new value and move to the following parameter.
- **To Exit:** Press **SET + UP** or wait 15s without pressing a key.

# QuickDraw® Storage and Semi-instantaneous Steam Heater

## 7.13 LED Display Alarm Messages

Alarm messages are displayed in the upper LED readout and alternate with the default display. An alarm LED ICON is also illuminated.

ALARM MESSAGE	CAUSE	RESULTS OF ALARM CONDITION	RECOMMENDED ACTION
"P1"	TP1 probe failure	Inlet temperature sensor is not connected or is reading incorrectly. Call for heat and burner modulation output signal will revert to low fire.	Check wiring and sensor Terminals 14 & 17
"P2"	TP2 probe failure	Temperature sensor is not connected or is reading incorrectly.	Check wiring and sensor Terminals 15 & 17
"P3"	TP3 probe failure	Temperature sensor is not connected or is reading incorrectly or flue gas temperature protection is disabled.	Check wiring and sensor Terminals 16 & 17
"HA"	High temperature limit setpoint exceeded	Audible alarm sounds, operation continues.	Manual reset required
"LA"	Low temperature alarm	Audible alarm sounds, operation continues.	
AL1	Digital input 1 is activated.	Unit de-energized after timer delay. Audible alarm sounds.	Manually reset required
AL2	Digital input 2 is activated. This alarm indication is dedicated to the Alarm On Any Failure feature of this product.	Unit de-energized after timer delay. Audible alarm sounds. Alarm contacts close for remote indication of alarm. Internal alarm register will communicate an alarm condition through the Modbus RTU communication link.	Manually reset required
AL3	Digital input 3 is activated.	Unit de-energized after timer delay. Audible alarm sounds.	
Mn1	Maintenance alarm for output 1	Buzzer sounds, operation continues	Check wiring and sensor
Mn2	Maintenance alarm for output 2	Buzzer sounds, operation continues	Check wiring and sensor
Mn3	Maintenance alarm for output 3	Buzzer sounds, operation continues	Check wiring and sensor
"rtc"	The real time clock has lost its setting	Energy saving function disabled	Reprogram clock
CONTROL MESSAGE	CAUSE	RESULTS OF CONTROL CONDITION	NOTES
 On	A call-for-heat condition	The burner operating sequence should begin.	If the burner does not operate, check safety devices or Remote Proving Interlock
 Flashing	The remote enable/disable has been triggered	The small flame icon will flash indicating the standby state	The R1-R2 terminals have been opened by the remote master control. The heater will remain in standby.
	Integral circulation pump	The integral circulation pump will operate until the water temperature has equalized	Pump may operate before, during or after the call-for-heat



# QuickDraw® Storage and Semi-instantaneous Steam Heater

## 7.14 Audible Alarm

The TempTrac audible alarm is activated each time a connected alarm condition occurs. The following are representative alarm conditions that may be connected to and activate the TempTrac audible alarm (some alarms may be connected to and operate separately from the TempTrac on some products).

- High/low water temperature alarm
- Probe failures
- External thermostat limit failure
- Low water

The audible alarm is silenced by pressing any button (alarm condition still present).

## 7.15 Alarm Recovery

- Probe failure alarm automatically ends after normal operation is re-established. Check connections before replacing the probe.
- Temperature alarms “**HA**” and “**LA**” automatically stop as soon as probe 1 senses temperatures within normal operating parameters.
- Digital input 2 & 3 alarms recover when condition(s) listed above are normalized and any button is pressed (if used). Resetting the alarm condition may require resetting individual safety devices or cycling main power switch.
- RTC alarm stops after programming the real time clock.
- RTF alarm requires the replacement of the real time clock.

**For additional information, contact the PVI Industries Customer Service Dept at 800-433-5654.**

# QuickDraw<sup>®</sup> Storage and Semi-instantaneous Steam Heater

## 8 START-UP PROCEDURE

1. After all the steam, condensate and water lines are installed and inspected, the steam supply source and the condensate receiver should be checked for correct operation. Steam supply pressure to the heater must be equal to or less than the supply pressure on the heater decal. A pressure reducing valve can be installed in the supply line to meet this requirement.
2. Steam is directed to the heat exchanger through a header and steam control valves. The steam control valves are normally closed, on-off, electric valves and solenoid-operated. Should an electrical power failure occur, steam valves will close and stop steam flow to the unit.
3. When placing the unit into operation, open relief valve to purge air from top of tank and begin to fill the tank with cold water. Check for plumbing leaks. Be sure to fill the tank completely before closing the relief valve.

**CAUTION:** Do not energize the heater or circulating pump until the tank is full of water. Serious damage may result.

4. Push control switch, located on the control box, to activate the steam valve and thermostats. Check steam valve for operation; the valve solenoid should “click” “ON” to open valve(s) when operating switch is pushed “ON”. The tank-circulating pump should also operate. Check thermostat settings.

**Temperature Setting:** The operating thermostat is set at the factory at approximately 120°F and the upper operating thermostat is set at approximately 130°F. Make adjustments by turning the thermostat dial to the desired temperature. The temperature limited device is factory set at 200°F.

**CAUTION:** Gradually introduce fluids to the unit. Failure to do so can cause damage to the heat exchanger.

5. Push the operating switch, located on the control box, to “OFF” before opening manual main steam supply valve. This will allow condensate that has collected in the supply line to drain through the trap installed in front of the steam valve. When the steam supply line is free of condensate, push operating switch to “ON”, opening the electric on-off steam valves allowing steam to flow through the heat exchanger.

**WARNING: Do not operate unit under conditions in excess of those specified on nameplate and ASME data plate. Failure to operate the heat exchanger within the specified design pressure and temperature may result in damage to the heat exchanger, property damage, personal injury or death.**

6. Open nearby hot water tap to maintain a flow of water through the tank when starting up units. Regulate flow of water through the tank to allow the steam valve(s) to cycle off and on. Observe condensate flow at the receiver or other collection sight to verify satisfactory flow. Check operation of all safety and operating controls.
7. In all installations, there should be no pulsation or water hammer since this causes vibration and strain with resulting leaks.
8. Retighten bolting on all gasketed joints after the heat exchanger has reached temperature to prevent leaks and gasket failures. Retightening should be done uniformly and in a diametrically staggered pattern; (see “Maintenance” for proper torque specs).
  - a. On high pressure and high temperature applications or any application where spiral wound gaskets are required, it is recommended that the gasketed joints of the heat exchanger be retightened to the required torque (see “Maintenance”) after 24 hours at operating pressures and temperatures to compensate for any relaxation or creep that may have occurred.
  - b. In shutting down, remove all power from the system. Close all steam and cold water supply valves to the unit.
  - c. If the unit is removed from service for an extended period, it must be drained to eliminate the possibility of freezing and corrosion from stagnant water conditions.

# QuickDraw® Storage and Semi-instantaneous Steam Heater

## 9 MAINTENANCE

**WARNING:** Turn off all electrical service to the appliance when accessing the remote connections located inside the control cabinet. These terminals are high voltage. If the electrical service is not turned off and these terminals are touched, a dangerous shock causing personal injury or death could occur. Close and fasten the control cabinet cover before restoring electrical service to the appliance.

### 9.1 Temperature and Pressure Relief Valve

Operate the temperature and pressure relief valve at least once a year by lifting the lever briefly. If the valve does not open and close properly when testing, it must be replaced with a like relief valve.

### 9.2 Thermostats and Temperature Limiting Device

The temperature limiting device and thermostat temperature sensors extend into the water in the tank. Depending on the water conditions in your area, scale may coat the sensors. This coating will affect accuracy of sensors and can allow water temperature to exceed the desired limits. Remove and inspect these controls at necessary intervals. Remove scale if present.

### 9.3 Steam Valve Actuator

The steam valve actuator (if applicable) is sealed and requires no maintenance. Durability of valve stems and packing is dependent upon maintaining non-damaging water conditions. Inadequate water treatment or filtration can result in corrosion, scale, and abrasive particle formation. Scale and particulates can result in stem and packing scratches and can adversely affect packing life and other parts of the hydronic system. Contact the manufacturer for replacement packing and stem & plug assembly.

### 9.4 Tank

Depending on water quality and operating temperature, scale can form during operation and will accumulate on the bottom of the tank. Natural minerals in water forms scale, which precipitates out during the heating cycles. Some water supplies contain more of these minerals than others, so scale buildup will occur more rapidly. Other factors affecting the scale buildup are the amount of hot water used and the temperature of the water. The more hot water used the more fresh water containing the scale-forming minerals come into the tank. As the temperature of the water increases, the rate of scale deposited also increases. The frequency of inspections will be determined by the rate of scale buildup. Until the appropriate inspection and cleaning frequency is established, inspect the tank every six months or more frequently if higher scaling conditions are present.

Flush the tank at the appropriate interval, based on water conditions in your location, to help prevent the accumulation of scale. **To flush:** turn off the electrical disconnect switch to remove power and prevent the unit from operating. Open the drain valve and allow water to flow through the tank until it runs clear. Close the drain valve and turn the electrical switch back on.

**NOTICE:** Since PVI cannot control the use of the appliance, water conditions, or maintenance, the warranty on the appliance does not cover poor performance, structural failure, or leaking due to an excessive accumulation of scale.

- a. If the unit requires shut down, remove all power from the system. Close all steam and cold water supply valves to the unit.
- b. If the unit is removed from service for an extended period of time, it must be drained completely to reduce the risk of freezing, biologic growth and corrosion from stagnant water conditions. When the appliance is returned to service, conduct a thorough inspection of all utilities and general appliance condition.

### 9.5 Cleaning the Heat Exchanger

1. **Do not** open until all pressure is removed, the unit is drained and the equipment surfaces cooled to ambient temperature.
2. Heat exchangers subject to fouling or scaling should be cleaned periodically. A light sludge or scale coating on the tube greatly reduces its effectiveness. A marked increase in pressure drop and/or reduction in performance usually indicate cleaning is necessary.
3. Tube bundle removal:
  - a. When practical and if the heat exchanger is connected to a collar assembly, leave tube bundle attached to collar assembly and remove by unbolting collar assembly from tank.

## QuickDraw® Storage and Semi-instantaneous Steam Heater

- b. During bundle removal, the dead weight of the bundle should never be supported on individual tubes or contact any lined interior tank surface. Following removal, rest the bundle on the tube sheet, support plates, or wood blocks cut to fit periphery of the bundle.
- c. Tube bundles may be raised using slings formed by bending light sheet metal into a “U” form and attaching lifting lugs to the ends of the sheets. Baffles can be easily bent and damaged if dragged over rough surfaces.
- d. Before reinserting the tube bundle into the unit place the ring/tank gasket over the end of the tube bundle and bring forward to the backside of the tube sheet.

**CAUTION:** When cleaning a tube bundle, tubes should not be hammered on with any metallic tool and, in case it is necessary to use scrapers, care should be exercised that the scraper is not sharp enough to cut the metal of the tubes.

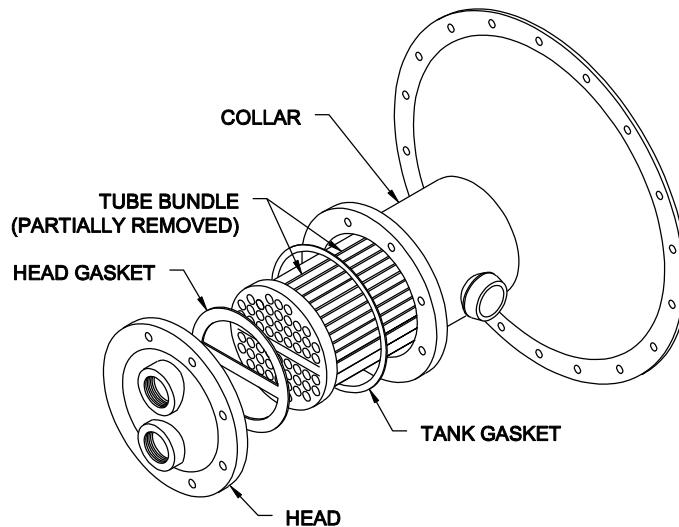

4. When replacing the heat exchanger HEAD, use a calibrated torque wrench to tighten the bolts/studs and nuts in an alternating star pattern. Use the following chart as a guide. All heat exchanger head torque values apply to well-lubricated nut bearing surfaces.

TIGHTENING TORQUES (LeaderKam (CamPro) or Dynagraph Gaskets)			
Bolt/Stud Dia.	Torque ft-lbs		Torque Increment
1/2"	60	± 4	5
5/8"	120	± 8	5

5. Tighten uniformly and in a diametrically staggered pattern as illustrated below:

**WARNING:** Follow the proper tightening sequence, torque increments and maximum torque values. Failure to follow these requirements can cause non-repairable damage to gaskets or heat exchangers and can result in leaking, property damage, personal injury or death.

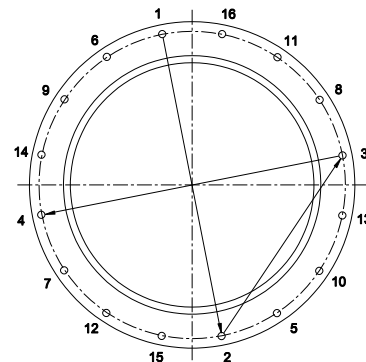

# QuickDraw® Storage and Semi-instantaneous Steam Heater

## 9.6 Bolted Head Removal

Some water heaters and storage tanks will have one or more removable 23" heads or bolted tank sections. The heads may be used for mounting an energy module (i.e. QuickDraw® steam or water heat exchanger heating elements) or bolted head for access to the tank. If a head or module is removed during the course of maintenance, replace the O-ring and all special high quality 9/16"-12 NC, grade 8 bolts, washers and nuts with identical parts available from your PVI representative or directly from PVI. Do not reuse or substitute these special fasteners with similar grade 8 bolts, washers and nuts. Install the flange bolts and nuts with a flat washer under each bolt head and nut. First, snug them in an alternating star pattern. Then, using a calibrated torque wrench, and in an alternating star pattern, tighten the bolts in 2 increments: 95 ft lbs and 145 ft lbs. Use a small amount of silicone RTV to hold the O-ring in place while positioning the flanged head or heat exchanger. Apply adhesive sparingly!

Contact PVI at 1-800-433-5654 for replacement Fastener Kits and O-Ring Replacement Instructions.

**IMPORTANT:** Mark one hole on head and on tank flange for reference when removing head. Be certain to align these holes during reassembly to insure the original gasket or O-ring mating surfaces will be correctly positioned.

**TYPICAL VERTICAL BOLTED HEAD ATTACHMENT**

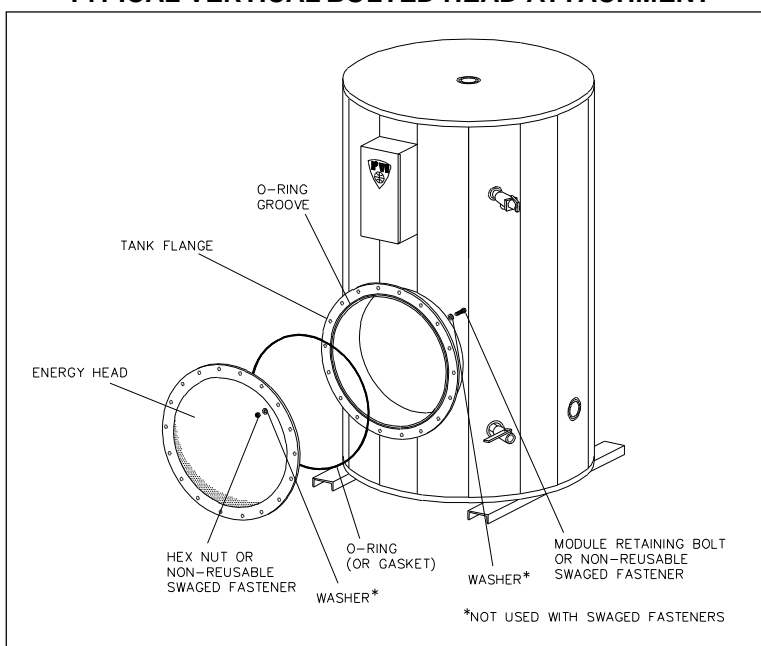

## 9.7 Recommended Maintenance Schedule

### 1. Annual Maintenance

- Check all joints and pipe connections for tightness, corrosion or deterioration.
- Check all safety controls and devices including thermostats for proper operation.
- Check safety shut-off valves for operation and tightness.
- Test high limit and operating temperature controls.

### 2. Semi-Annually

- Recalibrate all indicating and recording gauges.
- Check piping and wiring of all interlocks and shutoff valves.

### 3. Monthly Maintenance

- Test low-water cutoff device and alarm (if equipped).
- Check gauges, monitors, and indicators.
- Check instrument and equipment settings.

### 4. As Required

- Tank flush and cleanout.

# QuickDraw® Storage and Semi-instantaneous Steam Heater

## 10 TROUBLESHOOTING NOTES

### Problem 1: No hot water even at low flow.

- a. **Cause:** Steam valve(s) not opening.  
**Solution:** Check that electrical coils are energized. If not, trace wiring problem. If so, the valve may be faulty, the steam pressure inadequate to open the valve (< 5 psi depending on the valve), or the linkage (if applicable) is out of adjustment.
- b. **Cause:** Condensate flow is blocked.  
**Solution:** Float-type traps will not open if the inlet steam pressure exceeds the trap rating. Check steam pressure against the rating stamped on the trap. Check that there are no valves or clogged strainers between the heat exchanger and the condensate receiver.
- c. **Cause:** PGM system tripped.  
**Solution:** The pressure gradient monitoring option prevents the steam valve from opening if the water pressure in the tank is within 10 psi of the steam pressure. Correct water pressure problem.

### Problem 2: Heater recovery is slow or outlet temperature is below setpoint:

- a. **Cause:** Steam supply insufficient.  
**Solution:** Loss of steam delivery pressure, see below.
- b. **Cause:** Condensate not draining.  
**Solution:** Check that there is not excessive condensate lift. For low pressure steam, any lift at all may affect performance. Check the sizing of the trap. Check that the condensate receiver is not pressurized. Check that there is no blockage in the condensate line from the trap to the receiver. Unclog any strainers in the system.
- c. **Cause:** Condensate trap not operating.  
**Solution:** If the condensate temperature near the heat exchanger is considerably less than the steam temperature, then condensate is being backed up into the heat exchanger. Check that the supply steam pressure does not exceed the trap pressure rating. Check the trap for blockage or mechanical failure. Check that the trap is sized sufficiently for the load.
- d. **Cause:** Heat exchanger is breached.  
**Solution:** If excessive condensate is draining, the heat exchanger may have a leak and be filling with water.
- e. **Cause:** Heat exchanger is fouled.  
**Solution:** Inspect the heat exchanger for excessive scaling or fouling on the water side.
- f. **Cause:** Abnormal operating conditions.  
**Solution:** The water temperature has a significant effect on the efficiency of the heat exchanger. Check if the setpoint is higher than specified. Confirm the measured flow rate with meters or by volume and rate. Check that there are no other loads on the heater.

### Problem 3: Steam delivery pressure to heat exchanger is low or drops off:

- a. **Cause:** Low supply steam pressure.  
**Solution:** Unclog strainer. Check for blockage or restrictions in the line between the boiler and the water heater. Check for low boiler output or upstream blockage and make necessary corrections.
- b. **Cause:** Steam valve(s) not fully opening.  
**Solution:** Check steam pressure before and after steam valve. The pressure drop should not be more than half of the inlet pressure. Check valve for blockage. Check linkage for adjustment. Check modulating signal (if applicable). Check the supplied voltage to the valve coil.
- c. **Cause:** Piping flow restricted.  
**Solution:** Calculate the flow velocity and expected friction loss. If excessive, larger inlet and outlet piping are necessary.
- d. **Cause:** Main valve malfunction.  
**Solution:** Refer to the valve manual for instructions on main valve repair.
- e. **Cause:** Main valve undersized.  
**Solution:** Check steam pressure before and after steam valve. Check valve capacity against the load. If insufficient, increase trim or valve size.

# QuickDraw<sup>®</sup> Storage and Semi-instantaneous Steam Heater

## Problem 4: Outlet water temperature not constant.

- a. **Cause:** Insufficient recovery.  
**Solution:** If the thermostat or controller is always open, then the outlet temperature will vary with load. See above for causes of insufficient recovery.
- b. **Cause:** Malfunctioning or misadjusted thermostat(s).  
**Solution:** Measure the tank temperature near the thermostat and compare to setpoint. The thermostat should turn on and off within 5°F of setpoint.

## Problem 5: Unusual noises coming from heater.

- a. **Cause:** Flashing condensate.  
**Solution:** Pinging, rattling or banging noises are usually the result of condensate flashing to steam. Condensate not draining properly. Check that there is not excessive condensate lift. Check the sizing of the trap. Check that the condensate receiver is not pressurized. Check that there is no blockage in the condensate line from the trap to the receiver. Unclog any strainers in the system.

## Problem 6: Heat exchanger visibly leaking.

- a. **Cause:** Plumbing connection loose.  
**Solution:** Check and tighten plumbing connection.
- b. **Cause:** Double-wall heat exchanger tube leak.  
**Solution:** If one of the tube walls is breached, a double-wall heat exchanger will leak at the joint between the tubesheets. Isolate the heater and replace the heat exchanger.

# QuickDraw<sup>®</sup> Storage and Semi-instantaneous Steam Heater

---

Since PVI cannot control the use of the appliance, water conditions, or maintenance, the warranty on the heat exchanger does not cover poor performance, structural failure, or leaking due to an excessive accumulation of scale.

---

---

Warranty Forms Ship Separately with Each Product

MODEL NUMBER: \_\_\_\_\_

SERIAL NUMBER: \_\_\_\_\_

INSTALLATION DATE: \_\_\_\_\_